

Operating Instructions

Ceraphant PTC31B, PTP31B, PTP33B

IO-Link

Process pressure measurement

Pressure switch for safe measurement and monitoring of
absolute and gauge pressure

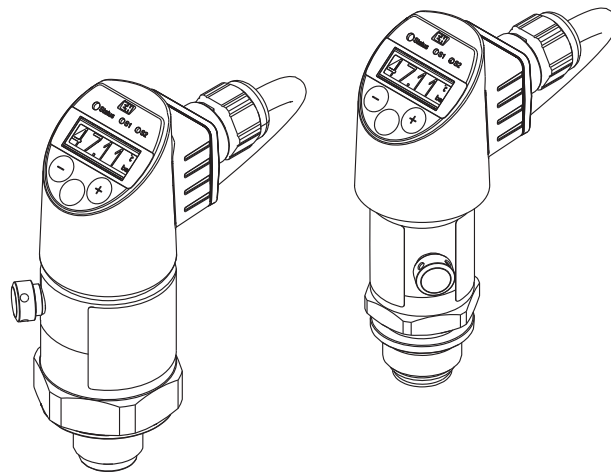

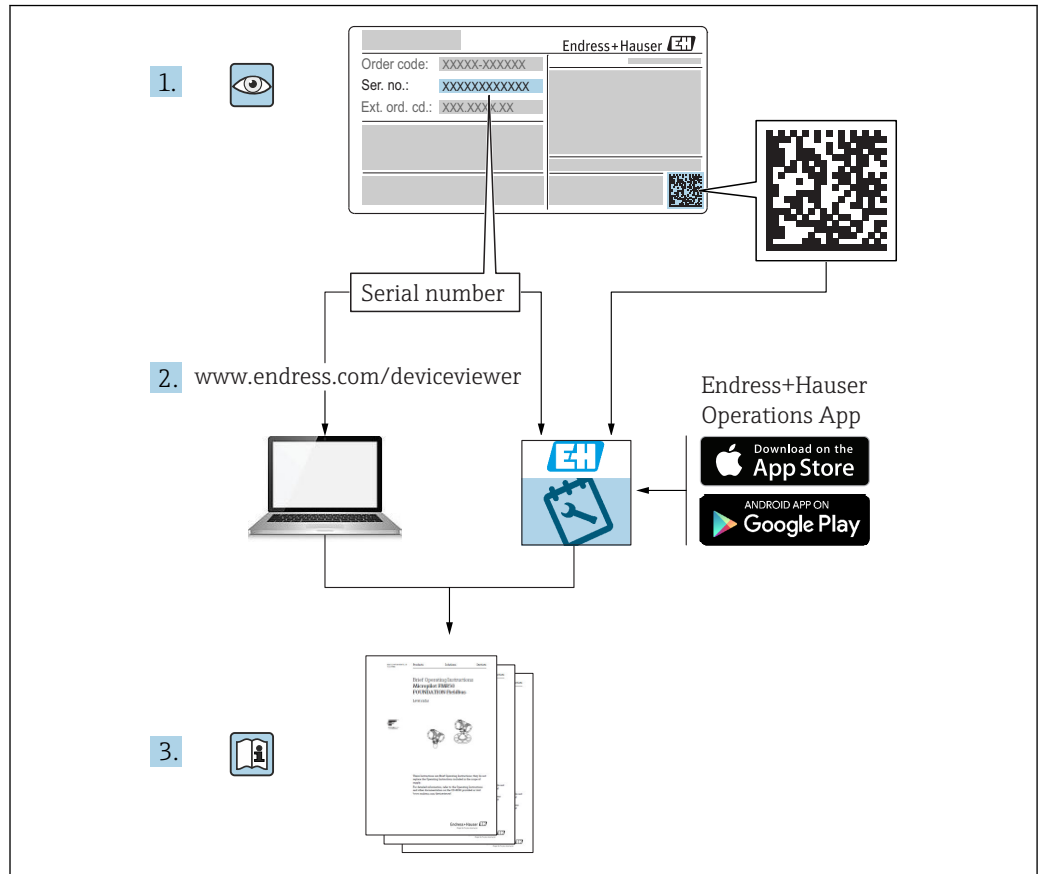

A0023555

- Make sure the document is stored in a safe place such that it is always available when working on or with the device.
- To avoid danger to individuals or the facility, read the "Basic safety instructions" section carefully, as well as all other safety instructions in the document that are specific to working procedures.
- The manufacturer reserves the right to modify technical data without prior notice. Your Endress+Hauser distributor will supply you with current information and updates to these Operating Instructions.

Table of contents

1	Document information	5	8	System integration	31
1.1	Document function	5	8.1	Process data	31
1.2	Symbols used	5	8.2	Reading out and writing device data (ISDU – Indexed Service Data Unit)	32
1.3	Documentation	6	8.3	Overview of diagnostic events	34
1.4	Terms and abbreviations	7	9	Commissioning	35
1.5	Turn down calculation	8	9.1	Function check	35
1.6	Registered trademarks	8	9.2	Commissioning with an operating menu	35
2	Basic safety instructions	9	9.3	Configuring pressure measurement	36
2.1	Requirements concerning the staff	9	9.4	Performing position adjustment	38
2.2	Designated use	9	9.5	Configuring process monitoring	40
2.3	Workplace safety	10	9.6	Current output	40
2.4	Operational safety	10	9.7	Application examples	43
2.5	Product safety	10	10	Diagnostics and troubleshooting ...	44
3	Product description	11	10.1	Troubleshooting	44
3.1	Product design	11	10.2	Diagnostic events	45
3.2	Function	11	10.3	Behavior of the device in the event of a fault ..	47
4	Incoming acceptance and product identification	13	10.4	Signal on alarm 4 to 20 mA	47
4.1	Incoming acceptance	13	10.5	Behavior of the device in the event of a voltage drop	48
4.2	Product identification	14	10.6	Behavior of the device in the event of an incorrect entry	48
4.3	Storage and transport	14	10.7	Resetting to factory settings (reset)	48
5	Installation	16	11	Maintenance	48
5.1	Mounting dimensions	16	11.1	Exterior cleaning	49
5.2	Installation conditions	16	12	Repairs	50
5.3	Influence of the installation position	16	12.1	General notes	50
5.4	Mounting location	17	12.2	Return	50
5.5	Mounting instructions for oxygen applications	19	12.3	Disposal	50
5.6	Post-installation check	19	13	Overview of the onsite display operating menu	51
6	Electrical connection	20	14	Overview of the IO-Link operating menu	54
6.1	Connecting the measuring unit	20	15	Description of device parameters ...	56
6.2	Switching capacity	22	15.1	Observation	74
6.3	Connection data	22	16	Accessories	75
6.4	Post-connection check	23	16.1	Weld-in adapter	75
7	Operation options	24	16.2	Process adapter M24	75
7.1	Operation with an operating menu	24	16.3	M12 plug connectors	76
7.2	Operation with local display	25			
7.3	General value adjustment and rejection of illegal entries	26			
7.4	Navigation and selection from list	26			
7.5	Locking and unlocking operation	28			
7.6	Navigation examples	30			
7.7	Status LEDs	30			
7.8	Resetting to factory settings (reset)	30			

17	Technical data	77
17.1	Input	77
17.2	Output	80
17.3	Performance characteristics of ceramic process isolating diaphragm	83
17.4	Performance characteristics of metal process isolating diaphragm	85
17.5	Environment	87
17.6	Process	88
Index		90





1 Document information

1.1 Document function



These Operating Instructions contain all the information that is required in various phases of the life cycle of the device: from product identification, incoming acceptance and storage, to mounting, connection, operation and commissioning through to troubleshooting, maintenance and disposal.

1.2 Symbols used

1.2.1 Safety symbols

Symbol	Meaning
	DANGER! This symbol alerts you to a dangerous situation. Failure to avoid this situation will result in serious or fatal injury.
	WARNING! This symbol alerts you to a dangerous situation. Failure to avoid this situation can result in serious or fatal injury.
	CAUTION! This symbol alerts you to a dangerous situation. Failure to avoid this situation can result in minor or medium injury.
	NOTICE! This symbol contains information on procedures and other facts which do not result in personal injury.



1.2.2 Electrical symbols





Symbol	Meaning	Symbol	Meaning
	Protective ground connection A terminal which must be connected to ground prior to establishing any other connections.		Ground connection A grounded terminal which, as far as the operator is concerned, is grounded via a grounding system.

1.2.3 Tool symbols

Symbol	Meaning
 A0011222	Open-ended wrench

1.2.4 Symbols for certain types of information

Symbol	Meaning
	Permitted Procedures, processes or actions that are permitted.
	Forbidden Procedures, processes or actions that are forbidden.
	Tip Indicates additional information.

Symbol	Meaning
	Reference to documentation
	Reference to page
	Reference to graphic
1. 2. 3. ...	Series of steps
	Result of a step
	Visual inspection

1.2.5 Symbols in graphics

Symbol	Meaning
1, 2, 3 ...	Item numbers
1. 2. 3. ...	Series of steps
A, B, C, ...	Views

1.3 Documentation

 The document types listed are available:
In the Download Area of the Endress+Hauser Internet site: www.endress.com → Download

1.3.1 Technical Information (TI): planning aid for your device

PTC31B: TI01130P

PTP31B: TI01130P

PTP33B: TI01246P

The document contains all the technical data on the device and provides an overview of the accessories and other products that can be ordered for the device.

1.3.2 Brief Operating Instructions (KA): getting the 1st measured value quickly

Devices with IO-Link: KA01404P

These instructions contain all the essential information from incoming acceptance to initial commissioning.

1.4 Terms and abbreviations

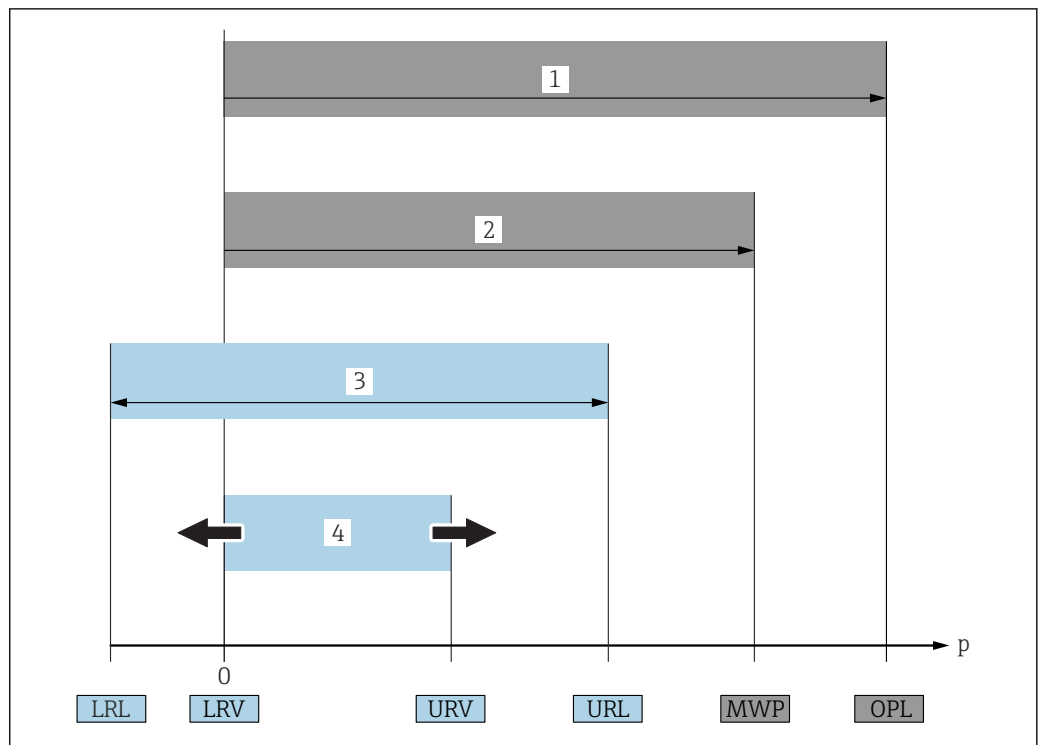

A0029505

Item	Term/ abbreviation	Explanation
1	OPL	The OPL (over pressure limit = sensor overload limit) for the measuring device depends on the lowest-rated element, with regard to pressure, of the selected components, i.e. the process connection has to be taken into consideration in addition to the measuring cell. Also observe pressure-temperature dependency. For the relevant standards and additional notes, see the "Pressure specifications" section → 89 . The OPL may only be applied for a limited period of time.
2	MWP	The MWP (maximum working pressure) for the sensors depends on the lowest-rated element, with regard to pressure, of the selected components, i.e. the process connection has to be taken into consideration in addition to the measuring cell. Also observe pressure-temperature dependency. For the relevant standards and additional notes, see the "Pressure specifications" section → 89 . The MWP may be applied at the device for an unlimited period. The MWP can also be found on the nameplate.
3	Maximum sensor measuring range	Span between LRL and URL This sensor measuring range is equivalent to the maximum calibratable/adjustable span.
4	Calibrated/adjusted span	Span between LRV and URV Factory setting: 0 to URL Other calibrated spans can be ordered as customized spans.
p	-	Pressure
-	LRL	Lower range limit
-	URL	Upper range limit
-	LRV	Lower range value
-	URV	Upper range value
-	TD (turn down)	Turn down Example - see the following section.

1.5 Turn down calculation

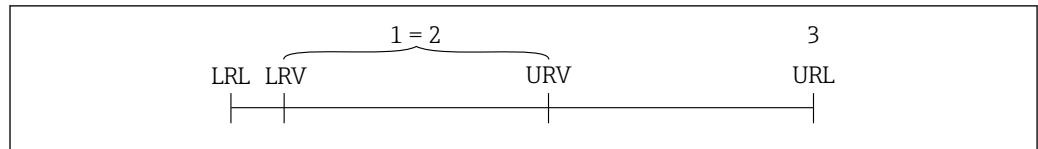

A0029545

- 1 *Calibrated/adjusted span*
- 2 *Zero point-based span*
- 3 *URL sensor*

Example

- Sensor: 10 bar (150 psi)
- Upper range value (URL) = 10 bar (150 psi)
- Calibrated/adjusted span: 0 to 5 bar (0 to 75 psi)
- Lower range value (LRV) = 0 bar (0 psi)
- Upper range value (URV) = 5 bar (75 psi)

Turn down (TD):

$$TD = \frac{URL}{|URV - LRV|}$$

$$TD = \frac{10 \text{ bar (150 psi)}}{|5 \text{ bar (75 psi)} - 0 \text{ bar (0 psi)}|} = 2$$

In this example, the TD is 2:1.
This span is based on the zero point.

1.6 Registered trademarks

 **IO-Link**

is a registered trademark of the IO-Link company group.

2 Basic safety instructions

2.1 Requirements concerning the staff

The personnel for installation, commissioning, diagnostics and maintenance must fulfill the following requirements:

- ▶ Trained, qualified specialists: must have a relevant qualification for this specific function and task
- ▶ Are authorized by the plant owner/operator
- ▶ Are familiar with federal/national regulations
- ▶ Before beginning work, the specialist staff must have read and understood the instructions in the Operating Instructions and supplementary documentation as well as in the certificates (depending on the application)
- ▶ Following instructions and basic conditions

The operating personnel must fulfill the following requirements:

- ▶ Being instructed and authorized according to the requirements of the task by the facility's owner-operator
- ▶ Following the instructions in these Operating Instructions

2.2 Designated use

2.2.1 Application and media

The Ceraphant is a pressure switch for measuring and monitoring absolute and gauge pressure in industrial systems. The process-wetted materials of the measuring device must have an adequate level of resistance to the media.

The measuring device may be used for the following measurements (process variables)

- in compliance with the limit values specified under "Technical data"
- in compliance with the conditions that are listed in this manual.

Measured process variable

Gauge pressure or absolute pressure

Calculated process variable

Pressure

2.2.2 Incorrect use

The manufacturer is not liable for damage caused by improper or non-designated use.

Verification for borderline cases:

- ▶ For special fluids and fluids for cleaning, Endress+Hauser is glad to provide assistance in verifying the corrosion resistance of process-wetted materials, but does not accept any warranty or liability.

2.2.3 Residual risks

When in operation, the housing may reach a temperature close to the process temperature.

Danger of burns from contact with surfaces!

- ▶ For elevated process temperatures, ensure protection against contact to prevent burns.

2.3 Workplace safety

For work on and with the device:

- ▶ Wear the required personal protective equipment according to federal/national regulations.
- ▶ Switch off the supply voltage before connecting the device.

2.4 Operational safety

Risk of injury!

- ▶ Operate the device in proper technical condition and fail-safe condition only.
- ▶ The operator is responsible for interference-free operation of the device.

Conversions to the device

Unauthorized modifications to the device are not permitted and can lead to unforeseeable dangers.

- ▶ If, despite this, modifications are required, consult with Endress+Hauser.

Hazardous area

To eliminate the risk of danger to persons or the facility when the device is used in the approval-related area (e.g. pressure equipment safety):

- ▶ Check the nameplate to verify if the device ordered can be put to its intended use in the approval-related area.

2.5 Product safety

This measuring device is designed in accordance with good engineering practice to meet state-of-the-art safety requirements, has been tested, and left the factory in a condition in which it is safe to operate.

It meets general safety standards and legal requirements. It also complies with the EU directives listed in the device-specific EU Declaration of Conformity. Endress+Hauser confirms this by affixing the CE mark to the device.

3 Product description

3.1 Product design

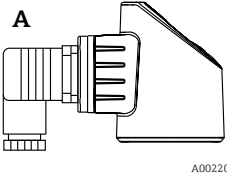
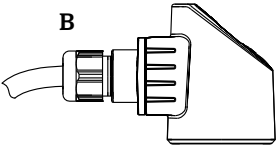
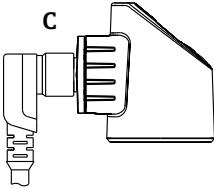
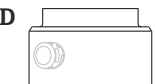
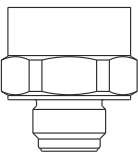
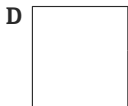
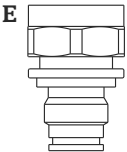
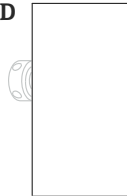
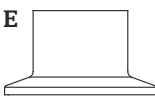
Overview	Item	Description
	A	Valve plug
	B	Cable
	C	M12 plug Housing cap made of plastic
	D	Housing
	E	Process connection (sample illustration)
	D	
	E	
	D	
	E	

3.2 Function

3.2.1 Calculating the pressure

Devices with ceramic process isolating diaphragm (Ceraphire®)

The ceramic sensor is an oil-free sensor, i.e. the process pressure acts directly on the robust ceramic process isolating diaphragm and causes it to deflect. A pressure-dependent

change in capacitance is measured at the electrodes of the ceramic substrate and the process isolating diaphragm. The measuring range is determined by the thickness of the ceramic process isolating diaphragm.

Devices with metallic process isolating diaphragm

The process pressure deflects the metal process isolating diaphragm of the sensor and a fill fluid transfers the pressure to a Wheatstone bridge (semiconductor technology). The pressure-dependent change in the bridge output voltage is measured and evaluated.

4 Incoming acceptance and product identification

4.1 Incoming acceptance

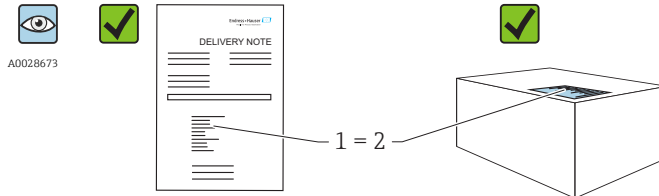

Is the order code on the delivery note (1) identical to the order code on the product sticker (2)?

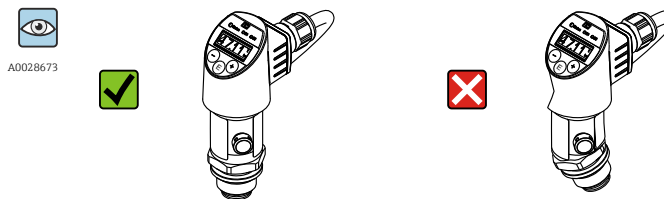
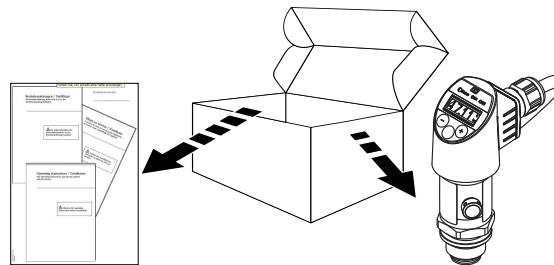

Are the goods undamaged?

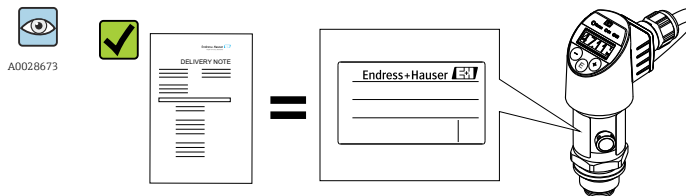

Do the data on the nameplate correspond to the order specifications and the delivery note?

 If one of these conditions does not apply, please contact your Endress+Hauser sales office.

4.2 Product identification

The following options are available for the identification of the measuring device:

- Nameplate specifications
- Order code with a breakdown of the device features on the delivery note
- Enter the serial numbers from the nameplates in *W@M Device Viewer* (www.endress.com/deviceviewer): All the information about the measuring device is displayed.

For an overview of the technical documentation provided, enter the serial number from the nameplates in *W@M Device Viewer* (www.endress.com/deviceviewer)

4.2.1 Manufacturer address

Endress+Hauser SE+Co. KG
Hauptstraße 1
79689 Maulburg, Germany

Address of the manufacturing plant: See nameplate.

4.2.2 Nameplate

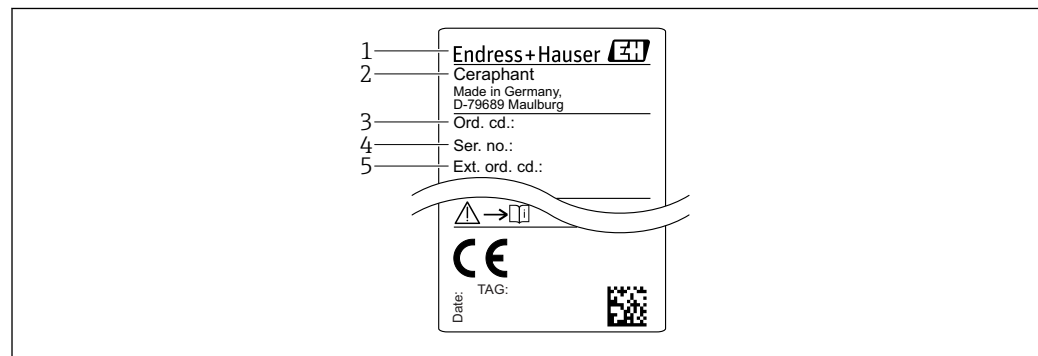

- 1 *Manufacturer's address*
- 2 *Device name*
- 3 *Order number*
- 4 *Serial number*
- 5 *Extended order number*

4.3 Storage and transport

4.3.1 Storage conditions

Use original packaging.

Store the measuring device in clean and dry conditions and protect from damage caused by shocks (EN 837-2).

Storage temperature range

-40 to +85 °C (-40 to +185 °F)

4.3.2 Transporting the product to the measuring point

⚠ WARNING

Incorrect transport!

Housing and diaphragm may become damaged, and there is a risk of injury!

- ▶ Transport the measuring device to the measuring point in its original packaging or by the process connection.

5 Installation

5.1 Mounting dimensions

For dimensions, see the "Mechanical construction" section in the Technical Information.

5.2 Installation conditions

- Moisture must not penetrate the housing when mounting the device, establishing the electrical connection and during operation.
- Do not clean or touch process isolating diaphragms with hard and/or pointed objects.
- Do not remove process isolating diaphragm protection until shortly before installation.
- Always tighten the cable entry firmly.
- Point the cable and connector downwards where possible to prevent moisture from entering (e.g. rain or condensation water).
- Protect housing against impact.
- For devices with gauge pressure sensor, the following applies:

NOTICE

If a heated device is cooled in the course of a cleaning process (by cold water, for example), a vacuum develops for a short time causing moisture to penetrate the sensor via the pressure compensation element (1).

Device could be destroyed!

- ▶ In the event of this happening, mount the device in such a way that the pressure compensation element (1) is pointing downwards at an angle or to the side, if possible.

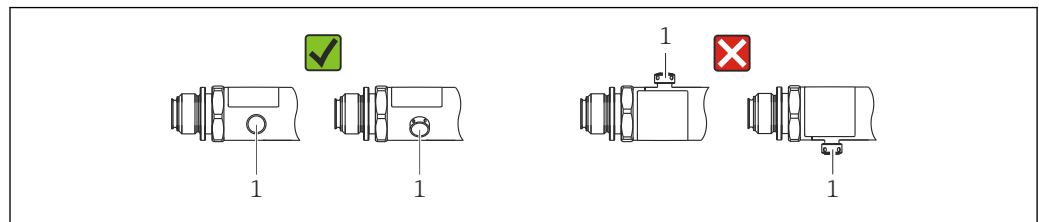

A0022252

5.3 Influence of the installation position

Any orientation is possible. However, the orientation may cause a zero point shift i.e. the measured value does not show zero when the vessel is empty or partially full.

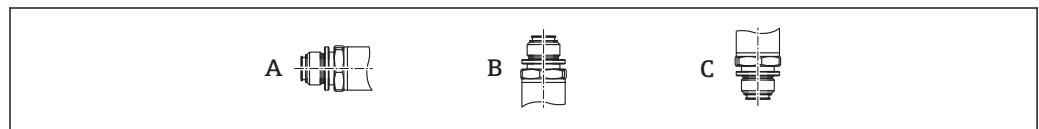

A0024708

Type	Process isolating diaphragm axis is horizontal (A)	Process isolating diaphragm pointing upwards (B)	Process isolating diaphragm pointing downwards (C)
PTP31B PTP33B	Calibration position, no effect	Up to +4 mbar (+0.058 psi)	Up to -4 mbar (-0.058 psi)
PTC31B < 1 bar (15 psi)	Calibration position, no effect	Up to +0.3 mbar (+0.0044 psi)	Up to -0.3 mbar (-0.0044 psi)
PTC31B ≥ 1 bar (15 psi)	Calibration position, no effect	Up to +3 mbar (+0.0435 psi)	Up to -3 mbar (-0.0435 psi)

 A position-dependent zero shift can be corrected on the device .

5.4 Mounting location

5.4.1 Pressure measurement

Pressure measurement in gases

Mount the device with shutoff device above the tapping point so that any condensate can flow into the process.

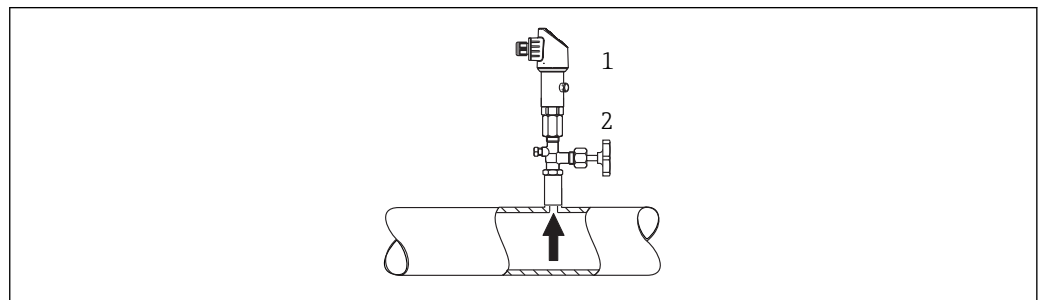

- 1 Device
2 Shutoff device

Pressure measurement in vapors

For pressure measurement in vapors, use a siphon. The siphon reduces the temperature to almost ambient temperature. Preferably mount the device with the shutoff device and siphon below the tapping point.

Advantage:

- defined water column causes only minor/negligible measuring errors and
- only minor/negligible heat effects on the device.

Mounting above the tapping point is also permitted.

Note the max. permitted ambient temperature of the transmitter!

Take the influence of the hydrostatic water column into consideration.

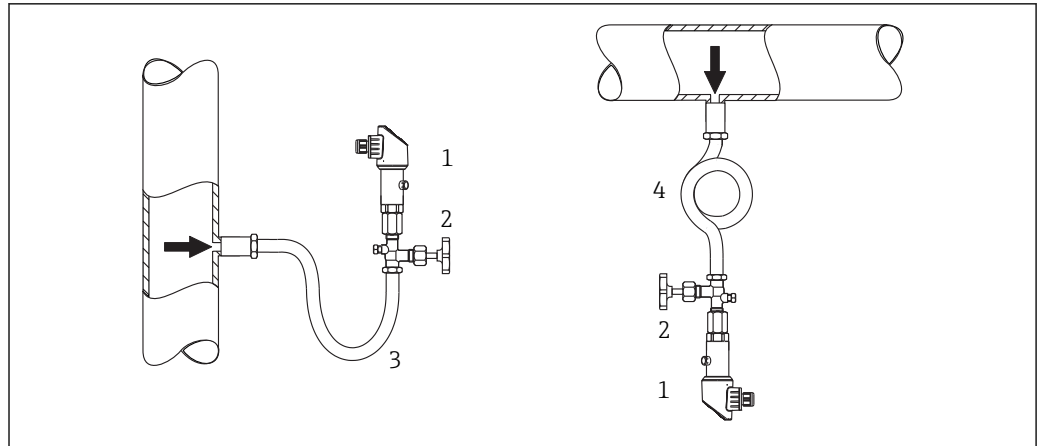

A0025921

- 1 Device
- 2 Shutoff device
- 3 Siphon
- 4 Siphon

Pressure measurement in liquids

Mount the device with a shutoff device and siphon below or at the same height as the tapping point.

Advantage:

- defined water column causes only minor/negligible measuring errors and
- air bubbles can be released to the process.

Take the influence of the hydrostatic water column into consideration.

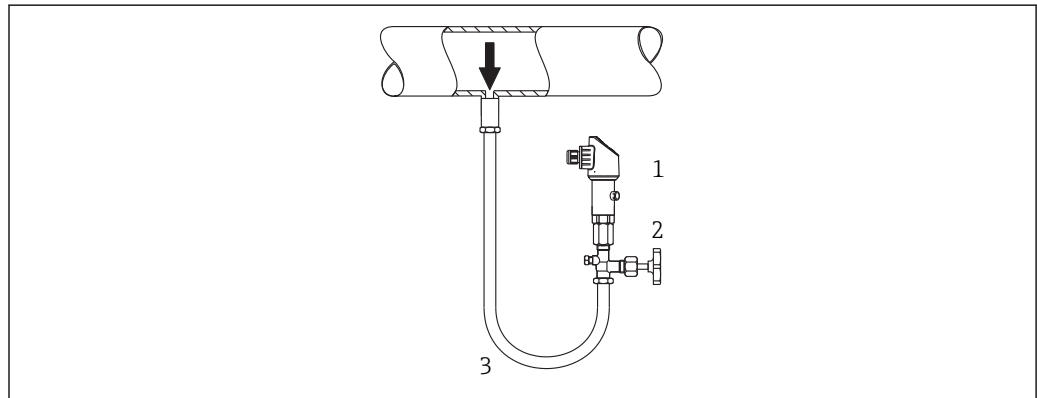

A0025922

- 1 Device
- 2 Shutoff device
- 3 Siphon

5.4.2 Level measurement

- Always install the device below the lowest measuring point.
- Do not install the device at the following positions:
 - In the filling curtain
 - In the tank outlet
 - in the suction area of a pump
 - Or at a point in the tank which could be affected by pressure pulses from the agitator.
- A functional test can be carried out more easily if you mount the device downstream from a shutoff device.

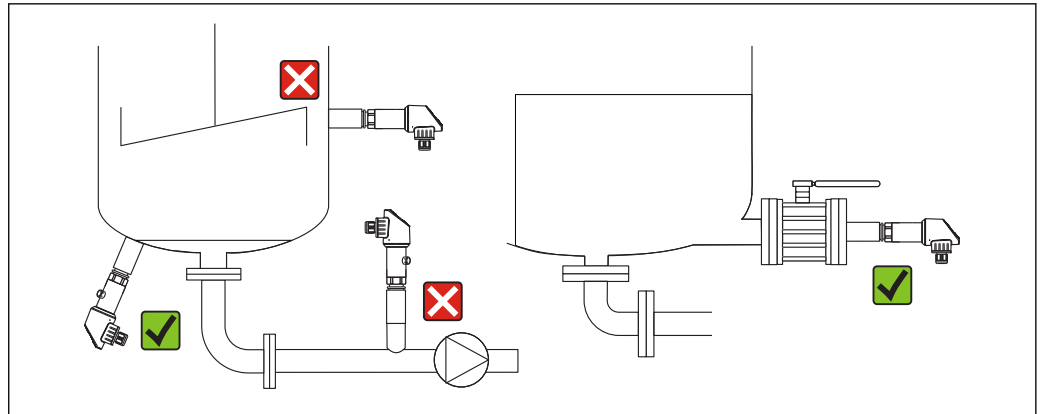

A0025923

5.5 Mounting instructions for oxygen applications

Oxygen and other gases can react explosively to oils, grease and plastics, such that, among other things, the following precautions must be taken:

- All components of the system, such as measuring devices, must be cleaned in accordance with the BAM requirements.
- Dependent on the materials used, a certain maximum temperature and a maximum pressure for oxygen applications must not be exceeded.
- The following table lists devices (devices only, not accessories or enclosed accessories), which are suitable for gaseous oxygen applications.

Device	p _{max} for oxygen applications	T _{max} for oxygen applications	Option ¹⁾
PTC31B	40 bar (600 psi)	-10 to +60 °C (+14 to +140 °F)	HB

1) Product Configurator, order code for "Service"

5.6 Post-installation check

<input type="checkbox"/>	Is the device undamaged (visual inspection)?
<input type="checkbox"/>	Does the device comply with the measuring point specifications? For example: <ul style="list-style-type: none"> ▪ Process temperature ▪ Process pressure ▪ Ambient temperature range ▪ Measuring range
<input type="checkbox"/>	Are the measuring point identification and labeling correct (visual inspection)?
<input type="checkbox"/>	Is the device adequately protected against precipitation and direct sunlight?
<input type="checkbox"/>	Are the securing screws tightened securely?
<input type="checkbox"/>	Is the pressure compensation element pointing downwards at an angle or to the side?
<input type="checkbox"/>	To prevent moisture from penetrating, ensure that the connecting cables/plugs are pointing downwards.

6 Electrical connection

6.1 Connecting the measuring unit

6.1.1 Terminal assignment

⚠ WARNING

Risk of injury from the uncontrolled activation of processes!

- ▶ Switch off the supply voltage before connecting the device.
- ▶ Make sure that downstream processes are not started unintentionally.

⚠ WARNING

Electrical safety is compromised by an incorrect connection!

- ▶ In accordance with IEC/EN61010 a separate circuit breaker must be provided for the device .
- ▶ The device must be operated with a 630 mA fine-wire fuse (slow-blow).
- ▶ Protective circuits against reverse polarity are integrated.

NOTICE

Damage to analog input of PLC resulting from incorrect connection

- ▶ Do not connect the active PNP switch output of the device to the 4 to 20 mA input of a PLC.

Connect the device in the following order:

1. Check that the supply voltage corresponds to the supply voltage indicated on the nameplate.
2. Connect the device in accordance with the following diagram.

Switch on supply voltage.

1 x PNP switch output R1 (not with IO-Link functionality)

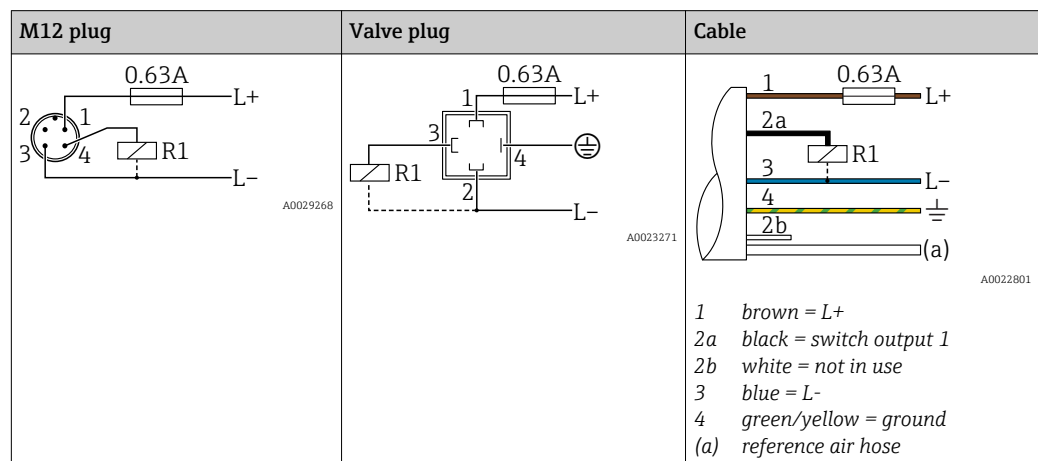

2 x PNP switch output R1 and R2 (not with IO-Link functionality)

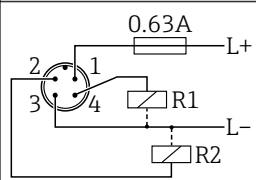
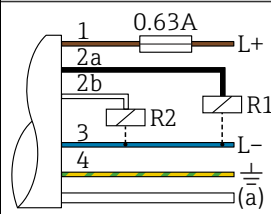
M12 plug	Valve plug	Cable
 <p>A0023248</p>	-	 <p>A0023282</p> <p>1 brown = L+ 2a black = switch output 1 2b white = switch output 2 3 blue = L- 4 green/yellow = ground (a) reference air hose</p>

IO-Link: 2 x PNP switch output R1 and R2

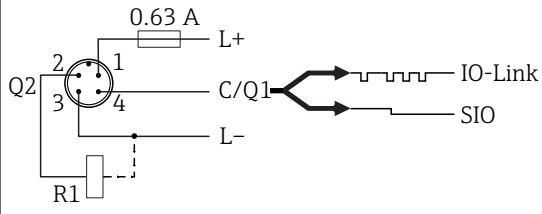
M12 plug
 <p>A0036997</p>

1 x PNP switch output R1 with additional analog output 4 to 20 mA (active), (not with IO-Link functionality)

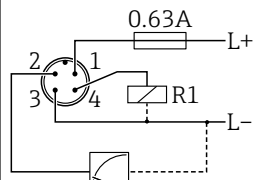
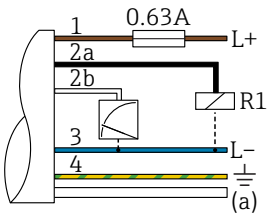
M12 plug	Valve plug	Cable
 <p>A0023249</p>	-	 <p>A0030519</p> <p>1 brown = L+ 2a black = switch output 1 2b white = analog output 4 to 20 mA 3 blue = L- 4 green/yellow = ground (a) reference air hose</p>

IO-Link: 1 x PNP switch output R1 with additional analog output 4 to 20 mA (active)

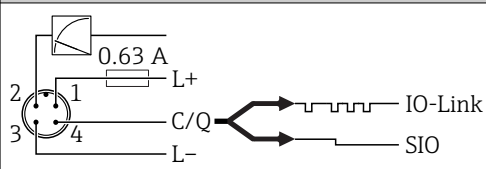
M12 plug
 <p>A0036998</p>

6.1.2 Supply voltage

Supply voltage IO-Link: 10 to 30 V DC at a DC power unit

IO-Link communication is guaranteed only if the supply voltage is at least 18 V.

6.1.3 Current consumption and alarm signal

Intrinsic power consumption	Alarm current (for devices with analog output) ¹⁾
≤ 60 mA	≥21 mA (factory setting)
Maximum current consumption: ≤ 300 mA	

- 1) Setting min. alarm current ≤3.6mA can be ordered via the product order structure. Min. alarm current ≤3.6mA can be configured at the device or via IO-Link.

6.2 Switching capacity

- Switch state ON ¹⁾: $I_a \leq 200 \text{ mA}$ ²⁾; switch state OFF: $I_a \leq 100 \mu\text{A}$
- Switch cycles: >10,000,000
- Voltage drop PNP: ≤2 V
- Overload protection: Automatic load testing of switching current;
 - Max. capacitive load: 1 μF at max. supply voltage (without resistive load)
 - Max. cycle duration: 0.5 s; min. t_{on} : 40 μs
 - Periodic disconnection from protective circuit in the event of overcurrent ($f = 2 \text{ Hz}$) and "F804" displayed

6.3 Connection data

6.3.1 Load (for devices with analog output)

In order to guarantee sufficient terminal voltage, a maximum load resistance R_L (including line resistance) must not be exceeded depending on the supply voltage U_B of the supply unit.

The maximum load resistance depends on the terminal voltage and is calculated according to the following formula:

- 1) 100 mA can be guaranteed over the entire temperature range for the switch outputs "2 x PNP" and "1 x PNP + 4 to 20 mA output". For lower ambient temperatures, higher currents are possible but cannot be guaranteed. Typical value at 20 °C (68 °F) approx. 200 mA. 200 mA can be guaranteed over the entire temperature range for the "1 x PNP" current output.
- 2) Larger currents are supported, thus deviating from the IO-Link standard.

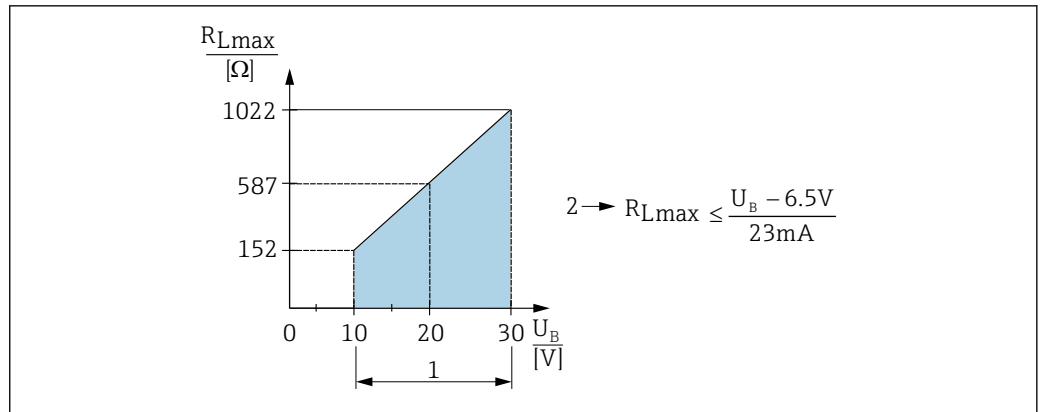

A0031107

- 1 Power supply 10 to 30 V DC
- 2 R_{Lmax} maximum load resistance
- U_B Supply voltage

If load is too great:

- failure current is output and "S803" displayed (output: MIN alarm current)
- Periodic checking to establish if it is possible to quit fault state
- In order to guarantee sufficient terminal voltage, a maximum load resistance R_L (including line resistance) must not be exceeded depending on the supply voltage U_B of the supply unit.

6.4 Post-connection check

<input type="checkbox"/>	Is the device or cable undamaged (visual check)?
<input type="checkbox"/>	Do the cables comply with the requirements?
<input type="checkbox"/>	Do the cables have adequate strain relief?
<input type="checkbox"/>	Are all the cable glands installed, firmly tightened and leak-tight?
<input type="checkbox"/>	Does the supply voltage match the specifications on the nameplate?
<input type="checkbox"/>	Is the terminal assignment correct?
<input type="checkbox"/>	If required: has protective ground connection been established?
<input type="checkbox"/>	If supply voltage is present: is the device ready for operation and do values appear on the display module or is the green status LED lit?

7 Operation options

7.1 Operation with an operating menu

7.1.1 IO-Link

IO-Link information

IO-Link is a point-to-point connection for communication between the measuring device and an IO-Link master. The measuring device features an IO-Link communication interface type 2 with a second IO function on pin 4. This requires an IO-Link-compatible assembly (IO-Link master) for operation. The IO-Link communication interface enables direct access to the process and diagnostic data. It also provides the option of configuring the measuring device on the fly.

Physical layer, the measuring device supports the following features:

- IO-Link specification: version 1.1
- IO-Link Smart Sensor Profile 2nd Edition (supports minimum scope of IdentClass)
- SIO mode: yes
- Speed: COM2; 38.4 kBaud
- Minimum cycle time: 2.5 msec.
- Process data width: 32 bit
- IO-Link data storage: yes
- Block parameterization: yes

IO-Link download

<http://www.endress.com/download>

- Select "Software" as the media type.
- Select "Device Driver" as the software type.
Select IO-Link (IODD).
- In the "Text Search" field enter the device name.

<https://ioddfinder.io-link.com/>

Search by

- Manufacturer
- Article number
- Product type

7.1.2 Operating concept

Operation with an operating menu is based on an operation concept with "user roles".

User role	Meaning
Operator (display level)	Operators are responsible for the devices during normal "operation". This is usually limited to reading process values either directly at the device or in a control room. Should an error occur, these users simply forward the information on the errors but do not intervene themselves.
Maintenance (user level)	Service engineers usually work with the devices in the phases following device commissioning. They are primarily involved in maintenance and troubleshooting activities for which simple settings have to be made on the device. Technicians work with the devices over the entire life cycle of the product. Thus, commissioning and advanced settings and configurations are some of the tasks they have to carry out.

7.1.3 Structure of the operating menu

The menu structure has been implemented according to VDMA 24574-1 and complemented by Endress+Hauser-specific menu items.

User role	Submenu	Meaning/use
Operator (display level)	Display/operat.	Display of measured values, fault and information messages
Maintenance (user level)	Parameters on the topmost menu level.	Contains all the parameters that are needed to commission measuring operations. A wide range of parameters, which can be used to configure a typical application, is available at the start. After making settings for all these parameters, the measuring operation should be completely configured in the majority of cases.
	EF	The submenu "EF" (Extended Functions) contains additional parameters which allow more accurate configuration of the measurement, conversion of the measured value and scaling of the output signal.
	DIAG	Contains all the parameters that are needed to detect and analyze operating errors.

 For an overview of the operating menu, see →  51 and →  54

7.2 Operation with local display

7.2.1 Overview

A 1-line liquid crystal display (LCD) is used for display and operation. The local display shows measured values, fault messages and information messages and therefore supports the user through each operating step.

The display is fixed to the housing and can be electronically rotated 180° (see parameter description for "DRO" →  73). This ensures optimum readability of the local display and allows the device to be mounted upside down also.

During measuring operation, the display shows measured values, fault messages and notice messages. In addition, it is possible to switch to menu mode via the operating keys.

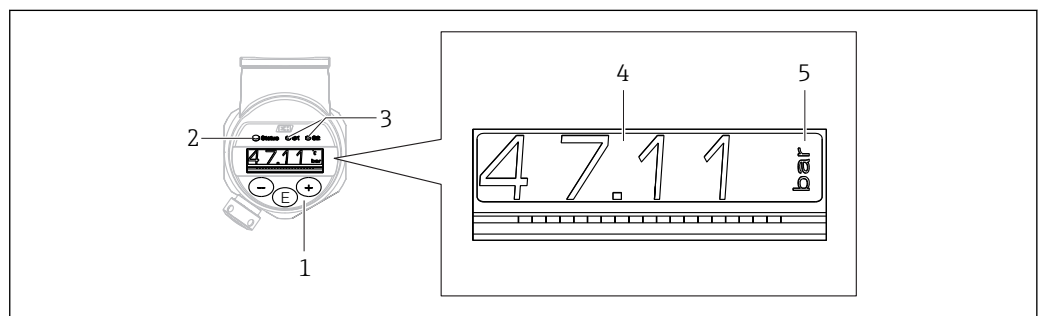

- 1 Operating keys
- 2 Status LED
- 3 Switch output LEDs
- 4 Measured value
- 5 Unit



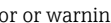

The second switch output is not used for the device version with current output.

7.2.2 Information on the operational states

Operational states	Function of status-LED and onsite display
Operation	<ul style="list-style-type: none"> Status LED is lit green LEDs of switch output 1 and switch output 2 signal the status of each switch output No activity of LED for switch output 2 if current output is active White background lighting
Problem	<ul style="list-style-type: none"> Status LED lit steady red Red display background LED of switch output 1 and switch output 2 off (switch output is deactivated)
Warning	<ul style="list-style-type: none"> Status LED flashing red White display background LEDs of switch output 1 and switch output 2 signal the status of each switch output
For Device Search	<ul style="list-style-type: none"> The green LED is lit (= operational) on the device and starts to flash with increased luminosity. Flash frequency  LEDs of switch output 1 and switch output 2 signal the status of each switch output Display background depending on the device status
IO-Link communication	<ul style="list-style-type: none"> Status LED flashes green as per IO-Link specification (regardless of measuring operation, error or warning). Flash frequency  Display background depending on the device status The state of switch output 1 is also indicated via the LED of switch output 1 at the same time as the process data are displayed

7.3 General value adjustment and rejection of illegal entries



Parameter (not numerical value) is flashing: parameter can be adjusted or selected.



When adjusting a numerical value: the numerical value does not flash. The first digit of the numerical value starts to flash only when the  key is pressed by way of confirmation. Enter the desired value with the  or  key and press the  key to confirm. Following confirmation, the data are recorded directly and are active.

- Entry is OK: value is accepted and shown for one second on the display against a white background.
- Entry is not OK: the message "FAIL" appears for one second on the display against a red background. The value entered is rejected. In the event of an incorrect setting which affects the TD, a diagnostic message is displayed.

7.4 Navigation and selection from list

The capacitive operating keys are used for navigation in the operating menu and to select an option from a picklist.

Operating key(s)	Meaning
 <small>A0017879</small>	<ul style="list-style-type: none"> Navigate downwards in the picklist Edit the numerical values or characters within a function
 <small>A0017880</small>	<ul style="list-style-type: none"> Navigate upwards in the picklist Edit the numerical values or characters within a function
 <small>A0017881</small>	<ul style="list-style-type: none"> Confirm entry Jump to the next item Select a menu item and activate the edit mode The key lock function (KYL) is accessed by pressing the key for longer than 2 seconds

Operating key(s)	Meaning
Simultaneously  and  A0017879 A0017880	ESC functions: <ul style="list-style-type: none">▪ Exit edit mode for a parameter without saving the changed value.▪ You are in a menu at a selection level. Each time you press the keys simultaneously, you go up a level in the menu.▪ Long ESC: press the keys for longer than 2 seconds

7.5 Locking and unlocking operation

The device features

- Automatic key locking
- Parameter settings lock.





Key locking is indicated on the local display by "E > 2".



Locking of the parameter settings is indicated as soon as an attempt is made to change a parameter.

7.5.1 Disabling the key lock

The keys are locked automatically if the device remains at the topmost menu level (display of pressure measurement value) for 60 seconds.

Call up the key lock function (KYL)

1. Press the  key for at least 2 seconds and then release it
2. By confirming with  "ON" is displayed
3. Use  and  to toggle between "ON" and "OFF"
4. Key locking is disabled as soon as  is pressed to confirm "OFF"

The display changes to the main value level (topmost menu level) if the  key is pressed briefly. The display changes to the key locking if the  key is pressed for at least 2 seconds.

If in the case of "KYL", "ON" or "OFF", more than 10 seconds elapse without a key being pressed, you return to the topmost menu level with active key locking.

The function can be accessed anytime outside the main measured value display and within the operating menu, i.e. if the  key is pressed for at least 2 seconds key locking can be performed anytime at any menu item. Locking is effective immediately. If you quit the context menu, you will return to the same point from which key locking was selected.

7.5.2 Locking and unlocking parameter settings

The device settings can be protected from unauthorized access.

COD parameter: define the locking code

0000	Device is permanently unlocked (factory setting)
0001-9999	Device is locked

LCK parameter: unlock parameter locking (enter the COD)

If parameters are locked, the word "LCK" appears on the local display as soon as an attempt is made to change a parameter.

Examples:

Locking the device with a customer-specific code

1. EF → ADM → COD
2. Enter a COD not equal to 0000 (value range: 0001 to 9999)
3. Wait 60 seconds or restart the device
4. Parameters are locked (protected against changes)

Changing a parameter when the device is locked (taking the example of STL)

1. STL, LCK is displayed

2. Enter the customer-specific value defined in COD
3. STL can be edited
4. The device is locked again after 60 seconds or following a restart

Unlocking the locking mechanism permanently

1. EF → ADM → COD
2. LCK is displayed, enter the customer-specific value defined in COD
3. Enter "0000"
4. The device is unlocked (even after the device is restarted)

7.6 Navigation examples

7.6.1 Parameters with a picklist

Example: Display measured value rotated by 180°

Menu path: EF → DIS → DRO

Press \oplus or \ominus key until "DRO" is displayed.	D R O
The default setting is "NO" (display is not rotated).	N O
Press \oplus or \ominus until "YES" appears (display is rotated by 180°).	Y E S
Press \boxtimes to confirm the setting.	D R O

7.6.2 User-definable parameters

Example: setting the "TAU" damping parameter.

Menu path: EF → TAU

Press \oplus or \ominus key until "TAU" is displayed.	T A U
Press \boxtimes to set the damping (min. = 0.0 s; max.= 999.9 s).	0. 3 0
Press \oplus or \ominus to go up or down. Press \boxtimes to confirm the entry and to go to the next position.	1. 5
Press \boxtimes to quit the setting function and to go to the "TAU" menu item.	T A U

7.7 Status LEDs

The Ceraphant also uses LEDs to signal the status:

- Two LEDs indicate the status of the switch outputs (switch output 2 can optionally be used as a current output)
- One LED indicates if the device is switched on or if an error or fault has occurred

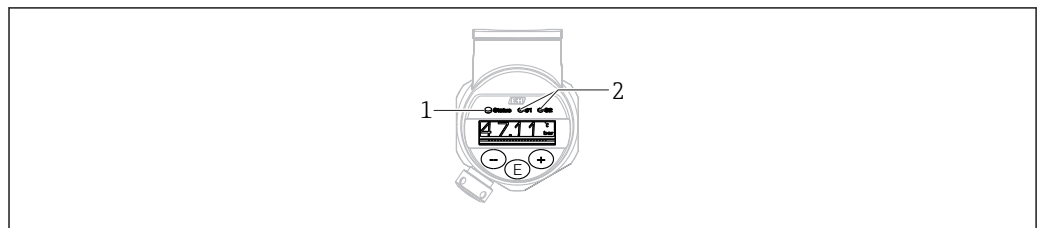

1 Status LED

2 Switch output LEDs

A0032027

7.8 Resetting to factory settings (reset)

See parameter description for RES → 71

8 System integration

8.1 Process data

The measuring device has one current output and one or two switch outputs (depending on the version ordered). The status of the switch outputs and the pressure value are transmitted in the form of process data via IO-Link.

- In the SIO mode, the switch output is switched at pin 4 of the M12 plug. In the IO-Link communication mode, this pin is reserved exclusively for communication.
- If the "with current output" option is ordered, the current output at pin 2 of the M12 plug is always active or can optionally be deactivated via IO-Link or at the display or configured as DC-PMP.
- The device's process data are transmitted cyclically in 32-bit chunks.

Bit	0 (LSB)	1	...	28	29 (MSB)	30	31
Measuring device	Pressure value					OU1	OU2

Bit 30 and bit 31 indicate the state of the switch outputs.

Here, 1 or DC 24 V corresponds to the logical "closed" state on the switch output. The remaining 30 bits contain the analog raw measured value of the device. This value has yet to be scaled by the target system to the nominal operating range of the existing measuring device.

Bit	Process value	Value range
31	OU1	0 = open 1 = closed
30	OU2	0 = open 1 = closed
0 to 29	Raw value	Integer

The pressure value is provided by the measuring device as int30. The decimal separator must be set with a gradient. The number of decimal places displayed is based on the display format of the device. The gradients depend on the unit in question. The following units are available:

- bar: 0.0001
- kPa: 0.01
- MPa: 0.00001
- psi: 0.001

Examples:

Pressure value	Transmitted	Scaled with gradient
-320 mbar	-3200	-0.32
22 bar	220000	22
133 kPa	13300	133
665 psi	665000	665
399.5 bar	3995000	399.5

8.2 Reading out and writing device data (ISDU – Indexed Service Data Unit)

Device data are always exchanged acyclically and at the request of the IO-Link master. Using the device data, the following parameter values or device statuses can be read out:

8.2.1 Endress+Hauser-specific device data

Designation	ISDU (dec)	ISDU (hex)	Size (byte)	Data type	Access	Default value	Value range	Offset / Gradient	Data storage
Extended Ordercode	259	0x0103	60	String	r/-				
ENP_VERSION	257	0x0101	16	String	r/-	36587			
Device Type	256	0x0100	2	UInteger16	r/-	0x92FE			
Simulation Switch Output (OU1)	85	0x0055			r/w	Off	0 ~ off, 1 ~ low, 2 ~ high,		
Simulation Current Output (OU2)	66	0x0042	1	uint	r/w	Off	4 ~ 4 mA, 5 ~ 8 mA, 6 ~ 12 mA, 7 ~ 16 mA, 8 ~ 20 mA, 9 ~ 21.95 mA, otherwise 3.5 mA		No
Simulation switch output (OU2)	86	0x0056	1	uint	r/w	Off	0 ~ off, 1 ~ low, 2 ~ high		No
Device search	87	0x0057	1	uint	r/w	Off	0 ~ off 1 ~ on		No
Operating Mode (FUNC)	88	0x0058	1	uint	r/w	1	0 ~ off, 1 ~ I, 2 ~ PNP		Yes
Unit changeover (UNI)	67	0x0043	1	uint	r/w		0 ~ bar, 1 ~ kPa, 2 ~ psi, 3 ~ MPa		Yes
Zero point configuration (ZRO)	68	0x0044	4	int	r/w	0	in 00.00%, default 0.00%		Yes
Zero point adoption (GTZ)	69	0x0045	1	uint	-/w				No
Damping (TAU)	70	0x0046	2	uint	r/w	20	in 000.0 sec, default 2.0 sec	0 / 0.1	Yes
Lower Range Value for 4 mA (STL)	71	0x0047	4	int	r/w	0	in 00.00%, default 0.00%	bar: 0 / 0.001 kPa: 0 / 0.1 MPa: 0 / 0.0001 psi: 0 / 0.01	Yes
Upper Range Value for 20 mA (STU)	72	0x0048	4	int	r/w	10000	in 00.00%, default 100.00%	bar: 0 / 0.001 kPa: 0 / 0.1 MPa: 0 / 0.0001 psi: 0 / 0.01	Yes
Pressure applied for 4mA (GTL)	73	0x0049	1	uint	-/w				No
Pressure applied for 20mA (GTU)	74	0x004A	1	uint	-/w				No
Alarm current (FCU)	75	0x004B	1	uint	r/w	MAX	0 ~ MIN, 1 ~ MAX, 2 ~ HOLD		Yes

Designation	ISDU (dec)	ISDU (hex)	Size (byte)	Data type	Access	Default value	Value range	Offset / Gradient	Data storage
Switch point value / Upper value for pressure window, output 1 (SP1 / FH1)	77	0x004D	4	int	r/w	9000	in 00.00%, default 90.00%	bar: 0 / 0.001 kPa: 0 / 0.1 MPa: 0 / 0.0001 psi: 0 / 0.01	Yes
Switchback point value / Lower value for pressure window, output 1 (rP1 / FL1)	78	0x004E	4	int	r/w	1000	in 00.00%, default 10.00%	bar: 0 / 0.001 kPa: 0 / 0.1 MPa: 0 / 0.0001 psi: 0 / 0.01	Yes
Switching delay time, output 1 (dS1)	79	0x004F	2	uint	r/w	0	in 00.00 sec	0 / 0.01	Yes
Switchback delay time, output 1 (dR1)	80	0x0050	2	uint	r/w	0	in 00.00 sec	0 / 0.01	Yes
Output 1 (OU1)	81	0x0051	1	uint	r/w	HNO	0 ~ HNO ¹⁾ , 1 ~ HNC ¹⁾ , 2 ~ FNO ¹⁾ , 3 ~ FNC ¹⁾		Yes
Switch point value / Upper value for pressure window, output 2 (SP2 / FH2)	89	0x0059	4	int	r/w	9500	in 00.00%, default 95.00%	bar: 0 / 0.001 kPa: 0 / 0.1 MPa: 0 / 0.0001 psi: 0 / 0.01	Yes
Switchback point value / Lower value for pressure window, output 2 (rP2 / FL2)	90	0x005A	4	int	r/w	1500	in 00.00%, default 15.00%	bar: 0 / 0.001 kPa: 0 / 0.1 MPa: 0 / 0.0001 psi: 0 / 0.01	Yes
Switching delay time, output 2 (dS2)	91	0x005B	2	uint	r/w	0	in 00.00 sec	0 / 0.01	Yes
Switchback delay time, output 2 (dR2)	92	0x005C	2	uint	r/w	0	in 00.00 sec	0 / 0.01	Yes
Output 2 (OU2)	93	0x005D	1	uint	r/w	HNC	0 ~ HNO ¹⁾ , 1 ~ HNC ¹⁾ , 2 ~ FNO ¹⁾ , 3 ~ FNC ¹⁾		Yes
Hi Max value (maximum indicator)	82	0x0052	4	int	r/-				No
Lo Min value (minimum indicator)	83	0x0053	4	int	r/-				No
Revisioncounter (RVC)	84	0x0054	2	uint	r/-				No
unlocking code (LCK)	94	0x005E	2	uint	-/w	0			Yes
locking code (COD)	95	0x005F	2	uint	-/w	0			Yes
Measured value display (DVA)	96	0x0060	1	uint	r/w	0	0 ~ PV for device with non-active current output 1 ~ PV% only for devices with active current output 2 ~ display set switch point SP		Yes
Display measured value rotated by 180° (DRO)	97	0x0061	1	uint	r/w	NO	0 ~ NO, 1 ~ YES		Yes
Switch display on or off (DOF)	98	0x0062	1	uint	r/w	NO	0 ~ NO, 1 ~ YES		Yes

1) For an explanation of the abbreviations, see the parameter description → 70

8.2.2 IO-Link-specific device data

Designation	ISDU (dec)	ISDU (hex)	Size (byte)	Data type	Access	Default value
Serial number	21	0x0015	max. 16	String	r/-	
Firmware version	23	0x0017	max. 64	String	r/-	
ProductID	19	0x0013	max. 64	String	r/-	PTx3xB
ProductName	18	0x0012	max. 64	String	r/-	Ceraphant
ProductText	20	0x0014	max. 64	String	r/-	Absolute and gauge pressure
VendorName	16	0x0010	max. 64	String	r/-	Endress+Hauser
VendorId	7 to 8	0x0007 to 0x0008			r/-	17
VendorText	17	0x0011	max. 64	String	r/-	People for Process Automation
DeviceId	9 to 11	0x0009 to 0x000B			r/-	0x000700
Hardware revision	22	0x0016	max. 64	String	r/-	
Application Specific Tag	24	0x0018	32	String	r/w	
Actual Diagnostics (STA)	260	0x0104	4	String	r/-	
Last Diagnostic (LST)	261	0x0105	4	String	r/-	

8.2.3 System commands

Designation	ISDU (dec)	ISDU (hex)	Value range	Access
Reset to factory settings (RES)	130	0x0082		w
Device Access Locks.Data Storage Lock	12	0x000C	0 ~ False 2 ~ True	rw
Device Access Locks.Local Parametrization Lock	130			w

8.3 Overview of diagnostic events

→  45

9 Commissioning

If an existing configuration is changed, measuring operation continues! The new or modified entries are only accepted once the setting has been made.

If block parameterization is used, a parameter change is only adopted after the parameter download.

⚠ WARNING

Risk of injury from the uncontrolled activation of processes!

- ▶ Make sure that downstream processes are not started unintentionally.

⚠ WARNING

If a pressure smaller than the minimum permitted pressure or greater than the maximum permitted pressure is present at the device, the following messages are output in succession:

- ▶ S140
- ▶ F270

NOTICE

An IO-DD with corresponding default values is used for all pressure measuring ranges. This IO-DD applies for all measuring ranges! The default values of this IO-DD can be inadmissible for this device. IO-Link messages (e.g. "Parameter value above limit") may be displayed when the device is updated with these default values. Existing values are not accepted in this case. The default values apply exclusively to the 10 bar (150 psi) sensor.

- ▶ The data must first be read out of the device before default values are written from the IO-DD to the device.



9.1 Function check

Before commissioning your measuring point, ensure that the post-installation and post-connection check have been performed:

- "Post-installation check" checklist →  19
- "Post-connection check" checklist

9.2 Commissioning with an operating menu

Commissioning comprises the following steps:

- Configure pressure measurement →  36
- Where applicable, perform position adjustment →  38
- Where applicable, configure process monitoring →  40

9.3 Configuring pressure measurement

9.3.1 Calibration without reference pressure (dry calibration = calibration without medium)

Example:



In this example, a device with a 400 mbar (6 psi) sensor is configured for the measuring range 0 to 300 mbar (0 to 4.4 psi).



The following values should be assigned:

- 0 mbar = 4 mA value
- 300 mbar (4.4 psi) = 20 mA value

Prerequisite:

This is a theoretical calibration, i.e. the pressure values for the lower and upper range are known. It is not necessary to apply pressure.

 Due to the orientation of the device, there may be pressure shifts in the measured value, i.e. the measured value is not zero in a pressureless condition. For information on how to perform position adjustment, see the "Performing position adjustment" section →  38.

 For a description of the parameters mentioned and possible error messages, see the "Description of device parameters" section →  56 and →  44.

Performing the configuration

1. Select a pressure unit, here "bar" for example, via the **Unit changeover (UNI)** parameter.
2. Select **Value for 4 mA (STL)** parameter. Enter the value (0 bar (0 psi)) and confirm.
 - ↳ This pressure value is assigned to the lower current value (4 mA).
3. Select **Value for 20 mA (STU)** parameter. Enter the value (300 mbar (4.4 psi)) and confirm.
 - ↳ This pressure value is assigned to the upper current value (20 mA).

The measuring range is configured for 0 to 300 mbar (0 to 4.4 psi).

9.3.2 Calibration with reference pressure (wet calibration = calibration with medium)

Example:



In this example, a device with a 400 mbar (6 psi) sensor is configured for the measuring range 0 to 300 mbar (0 to 4.4 psi).



The following values should be assigned:

- 0 mbar = 4 mA value
- 300 mbar (4.4 psi) = 20 mA value

Prerequisite:

The pressure values 0 mbar and 300 mbar (4.4 psi) can be specified. The device is already mounted, for example.

 Due to the orientation of the device, there may be pressure shifts in the measured value, i.e. the measured value is not zero in a pressureless condition. For information on how to perform position adjustment, see the "Performing position adjustment" section →  38.

 For a description of the parameters mentioned and possible error messages, see the "Description of device parameters" section →  56 and →  44.

Performing the configuration

1. Select a pressure unit, here "bar" for example, via the **Unit changeover (UNI)** parameter.
2. The pressure for the LRV (4 mA value) is present at the device, here 0 bar (0 psi) for example. Select **Pressure applied for 4mA (GTL)** parameter. The selection is confirmed by pressing "Get Lower Limit".
 - ↳ The pressure value present is assigned to the lower current value (4 mA).
3. The pressure for the URV (20 mA value) is present at the device, here 300 mbar (4.4 psi) for example. Select **Pressure applied for 20mA (GTU)** parameter. The selection is confirmed by pressing "Get Lower Limit".
 - ↳ The pressure value present is assigned to the upper current value (20 mA).

The measuring range is configured for 0 to 300 mbar (0 to 4.4 psi).

9.4 Performing position adjustment

Zero point configuration (ZRO)

Navigation	Display: EF → Zero point configuration (ZRO) IO-Link: Parameter → Application → Sensor → Zero point configuration (ZRO)
Description	(typically absolute pressure sensor) The pressure resulting from the orientation of the device can be corrected here. The pressure difference between zero (set point) and the measured pressure must be known.
Prerequisite	An offset is possible (parallel shifting of the sensor characteristic) to correct the orientation and any zero point drift. The set value of the parameter is subtracted from the "raw measured value". The requirement to be able to perform a zero point shift without changing the span is met with the offset function. Maximum offset value = ± 20 % of the sensor nominal range. If an offset value is entered that shifts the span beyond the physical limits of the sensor, the value is admitted but a warning message is generated and displayed via IO-Link. The warning message only disappears when the span is within the sensor limits, taking the offset value currently configured into consideration. The sensor can <ul style="list-style-type: none"> ▪ be operated in a physically unfavorable range, i.e. outside its specifications, or ▪ be operated by making appropriate corrections to the offset or span. Raw measured value – (manual offset) = display value (measured value)
Example	<ul style="list-style-type: none"> ▪ Measured value = 0.002 mbar (0.029 psi) ▪ Set the measured value in the parameter to 0.002. ▪ Measured value (after pos. zero adjust) = 0.000 mbar (0 psi) ▪ The current value is also corrected.
Note	Setting in increments of 0.001. As the value is entered numerically, the increment depends on the measuring range
Options	No selection. The user is free to edit the values.
Factory setting	0

Zero point adoption (GTZ)

Navigation	Display: EF → Zero point adoption (GTZ) IO-Link: Parameter → Application → Sensor → Zero point adoption (GTZ)
Description	(typically gauge pressure sensor) The pressure resulting from the orientation of the device can be corrected here. The pressure difference between zero (set point) and the measured pressure need not be known.

Prerequisite

The pressure value present is automatically adopted as the zero point. An offset is possible (parallel shifting of the sensor characteristic) to correct the orientation and any zero point drift. The accepted value of the parameter is subtracted from the "raw measured value". The requirement to be able to perform a zero point shift without changing the span is met with the offset function. Maximum offset value = $\pm 20\%$ of the sensor nominal range. If an offset value is entered that shifts the span beyond the physical limits of the sensor, the value is admitted but a warning message is generated and displayed via IO-Link. The warning message only disappears when the span is within the sensor limits, taking the offset value currently configured into consideration.

The sensor can

- be operated in a physically unfavorable range, i.e. outside its specifications, or
- be operated by making appropriate corrections to the offset or span.

Raw measured value – (manual offset) = display value (measured value)

Example 1

- Measured value = 0.002 mbar (0.029 psi)
- Use the **Zero point adoption (GTZ)** parameter to correct the measured value with the value, e.g. 0.002 mbar (0.029 psi). This means that you are assigning the value 0.000 (0 psi) to the pressure present.
- Measured value (after pos. zero adjust) = 0.000 mbar (0 psi)
- The current value is also corrected.
- Where applicable, check and correct switch points and span settings.

Example 2

Sensor measuring range: -0.4 to +0.4 bar (-6 to +6 psi) (SP1 = 0.4 bar (6 psi); STU = 0.4 bar (6 psi))

- Measured value = 0.08 bar (1.2 psi)
 - Use the **Zero point adoption (GTZ)** parameter to correct the measured value with the value, e.g. 0.08 bar (1.2 psi). This means that you are assigning the value 0 mbar (0 psi) to the pressure present.
 - Measured value (after pos. zero adjust) = 0 mbar (0 psi)
 - The current value is also corrected.
 - Warnings C431 or C432 appear because the value 0 bar (0 psi) was assigned to the real value of 0.08 bar (1.2 psi) present and the sensor measuring range was thus exceeded by $\pm 20\%$.
- SP1 and STU values must be readjusted downwards by 0.08 bar (1.2 psi).

9.5 Configuring process monitoring

To monitor the process, it is possible to specify a pressure range which is monitored by the limit switch. Both monitoring versions are described below. The monitoring function allows the user to define optimum ranges for the process (with high yields etc.) and deploy limit switches to monitor the ranges.



9.5.1 Digital process monitoring (switch output)

It is possible to select defined switch points and switchback points which act as NO or NC contacts depending on whether a window function or hysteresis function is configured.

Function	Selection	Output	Abbreviation for operation
Hysteresis	Hysteresis normally open	Closing	HNO
Hysteresis	Hysteresis normally closed	NC contact	HNC
Window	Window normally open	Closing	FNO
Window	Window normally closed	NC contact	FNC

If the device is restarted within the given hysteresis, the switch output is open (0 V present at the output).

9.5.2 Analog process monitoring (4 to 20 mA output)

- The 3.8 to 20.5 mA signal range is controlled according to NAMUR NE 43.
- The alarm current and current simulation are exceptions:
 - If the defined limit is exceeded, the device continues measuring linearly. The output current increases linearly up to 20.5 mA and holds the value until the measured value drops below 20.5 mA again or the device detects an error →  44.
 - If the defined limit is undershot, the device continues measuring linearly. The output current decreases linearly to 3.8 mA and holds the value until the measured value rises above 3.8 mA again or the device detects an error →  44.

9.6 Current output

Operating Mode (FUNC)

Navigation

Display: EF → Operating Mode (FUNC)
IO-Link: Parameter → Application → Sensor → Operating Mode (FUNC)

Description

Enables the desired behavior of output 2 (not IO-Link output)

Options

Options:

- OFF
- 4-20 mA (I) ((can only be selected if the device has been ordered with 4-20mA))
- DC-PNP (PNP)

Value for 4 mA (STL)

Navigation	Display: STL → Value for 4 mA (STL) IO-Link: Parameter → Application → Current output → Value for 4 mA (STL)
Description	Assignment of the pressure value which should correspond to the 4 mA value. It is possible to invert the current output. To do so, assign the pressure upper range value to the lower measuring current.
Note	Enter the value for 4 mA in the selected pressure unit anywhere within the measuring range. The value can be entered in increments of 0.1 (increment depends on the measuring range).
Options	No selection. The user is free to edit the values.
Factory setting	0.0 or as per order specifications

Value for 20 mA (STU)

Navigation	Display: STU → Value for 20 mA (STU) IO-Link: Parameter → Application → Current output → Value for 20 mA (STU)
Description	Assignment of the pressure value which should correspond to the 20 mA value. It is possible to invert the current output. To do so, assign the pressure lower range value to the upper measuring current.
Note	Enter the value for 20 mA in the selected pressure unit anywhere within the measuring range. The value can be entered in increments of 0.1 (increment depends on the measuring range).
Options	No selection. The user is free to edit the values.
Factory setting	Upper measuring limit or as per order specifications.

Pressure applied for 4mA (GTL)

Navigation	Display: EF → I → Pressure applied for 4mA (GTL) IO-Link: Parameter → Application → Current output → Pressure applied for 4mA (GTL)
-------------------	--

Description

The pressure value present is automatically adopted for the 4 mA current signal. Parameter for which the current range can be assigned to any section of the nominal range. This occurs by assigning the pressure lower range value to the lower measuring current and the pressure upper range value to the upper measuring current. The pressure lower range value and upper range value can be configured independently of one another so the pressure measuring span does not remain constant. The LRV and URV pressure measuring span can be edited over the entire sensor range. An invalid TD value is indicated by diagnostic message S510. An invalid position offset is indicated by diagnostic message C431. The editing operation cannot result in the device being operated outside the minimum and maximum sensor limits.

Incorrect entries are declined as indicated by the following messages, and the last valid value prior to the change is used again:

- Parameter value above limit (0x8031)
- Parameter value below limit (0x8032)

The measured value currently present is accepted as the value for 4mA anywhere within the measuring range. The sensor characteristic curve is shifted such that the pressure present becomes the zero value.

Pressure applied for 20mA (GTU)

Navigation

Display: EF → I → Pressure applied for 20mA (GTU)
 IO-Link: Parameter → Application → Current output → Pressure applied for 20mA (GTU)

Description

The pressure value present is automatically adopted for the 20 mA current signal. Parameter for which the current range can be assigned to any section of the nominal range. This occurs by assigning the pressure lower range value to the lower measuring current and the pressure upper range value to the upper measuring current. The pressure lower range value and upper range value can be configured independently of one another so the pressure measuring span does not remain constant. The LRV and URV pressure measuring span can be edited over the entire sensor range. An invalid TD value is indicated by diagnostic message S510. An invalid position offset is indicated by diagnostic message C431. The editing operation cannot result in the device being operated outside the minimum and maximum sensor limits. Incorrect entries are declined, and the last valid value prior to the change is used again. The measured value currently present is accepted as the value for 20 mA anywhere within the measuring range. There is a parallel shift of the sensor characteristic so that the pressure present becomes the max value.

9.7 Application examples

9.7.1 Compressor control with hysteresis function

Example: The compressor is started when the pressure drops below a certain value. The compressor is switched off when a certain value is exceeded.

1. Set the switch point to 2 bar (29 psi)
2. Set the switchback point to 1 bar (14.5 psi)
3. Configure the switch output as an "NC contact" (HNC function)

The compressor is controlled by the defined settings.

9.7.2 Pump control with hysteresis function

Example: The pump should switch on when 2 bar (29 psi) is reached (increasing pressure) and switch off when 1 bar (14.5 psi) is reached (decreasing pressure).

1. Set the switch point to 2 bar (29 psi)
2. Set the switchback point to 1 bar (14.5 psi)
3. Configure the switch output as an "NO contact" (HNO function)

The pump is controlled by the defined settings.

10 Diagnostics and troubleshooting

10.1 Troubleshooting

If an illegal configuration exists in the device, the device switches to the failsafe mode.

Example:

- The diagnostic message "C485" is displayed via IO-Link.
- The device is in the simulation mode.
- If the device configuration is corrected, e.g. by resetting the device, the device quits the fault state and switches to the measuring mode.

General errors

Problem	Possible cause	Remedy
Device does not respond	Supply voltage does not match that specified on the nameplate.	Apply correct voltage.
	Supply voltage has incorrect polarity.	Reverse polarity of supply voltage.
	Connecting cables are not in contact with the terminals.	Check for electrical contact between cables and correct.
No display	The local display might be switched off.	Switch on the local display (see the "DOF" parameter description).
Device measures incorrectly.	Configuration error.	Check and correct the parameter configuration.
No communication	<ul style="list-style-type: none"> ■ Communication cable not connected. ■ Communication cable incorrectly attached to device. ■ Communication cable incorrectly attached to the IO-Link master. 	Check wiring and cables.
Output current ≤ 3.6 mA	Signal line is not wired correctly.	Check wiring.
No transmission of process data	There is an error in the device.	Correct errors that are displayed as a diagnostic event → 46.
Parameter plausibility check has failed (IO-Link message as per IO-Link standard)	An IO-DD with corresponding default values is used for all pressure measuring ranges. This IO-DD applies for all measuring ranges! The default values of this IO-DD can be inadmissible for this device. IO-Link messages (e.g. "Parameter value above limit") may be displayed when the device is updated with these default values. Existing values are not accepted in this case. The default values apply exclusively to the 10 bar (150 psi) sensor.	The data must first be read out of the device before default values are written from the IO-DD to the device.

10.2 Diagnostic events

10.2.1 Diagnostic message

Faults detected by the self-monitoring system of the measuring device are output as a diagnostic message via IO-Link and displayed as a diagnostic message in alternation with the measured value display.

Status signals

The table →  46 lists the messages that may occur. The ALARM STATUS parameter shows the message with the highest priority. The device has four different status information codes according to NE107:



F <small>A0013956</small>	"Failure" A device error has occurred. The measured value is no longer valid.
M <small>A0013957</small>	"Maintenance required" Maintenance is required. The measured value is still valid.
C <small>A0013959</small>	"Function check" The device is in the service mode (e.g. during a simulation).
S <small>A0013958</small>	"Out of specification" The device is being operated: <ul style="list-style-type: none"> ▪ Outside its technical specifications (e.g. during warmup or cleaning process) ▪ Outside the parameter configuration undertaken by the user (e.g. level outside of configured span)

Diagnostics event and event text

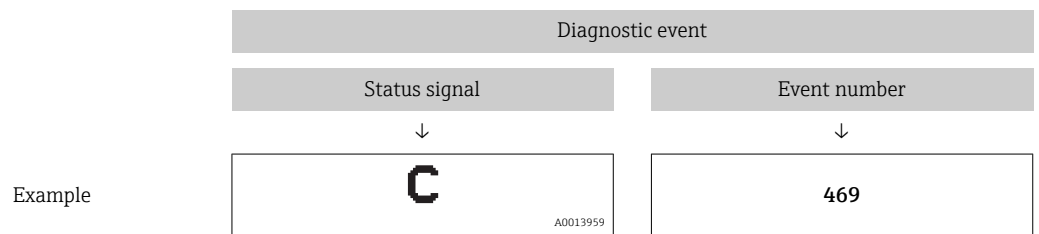
The fault can be identified by means of the diagnostic event.



If two or more diagnostics events are pending simultaneously, only the message with the highest priority is shown.

 The last diagnostic message is displayed - see Last Diagnostic (LST) in the **Diagnosis** submenu →  56.

10.2.2 Overview of diagnostic events

Status signal/ Diagnostic event	Diagnostic behavior	IO-Link EventQualifier	EventCode	Event text	Cause	Corrective measure
S140	Warning	IO-Link Warning	0x180F	Sensor signal outside of permitted ranges	Overpressure or low pressure present	Operate device in the specified measuring range
F270 ¹⁾	Fault	IO-Link Error	0x1800	Overpressure/low pressure	Overpressure or low pressure present	<ul style="list-style-type: none"> ▪ Check the process pressure ▪ Check sensor range ▪ Restart device
F270 ¹⁾	Fault	IO-Link Error	0x1800	Defect in electronics/sensor	Defect in electronics/sensor	Replace device
C431 ²⁾	Warning	IO-Link Warning	0x1805	Invalid position adjustment (Current output)	The adjustment performed would cause the sensor nominal range to be exceeded or undershot.	Position adjustment + parameter of the current output must be within the sensor nominal range <ul style="list-style-type: none"> ▪ Check position adjustment (see Zero point configuration (ZRO) parameter) ▪ Check measuring range (see Value for 20 mA (STU) and Value for 4 mA (STL) parameters)
C432	Warning	IO-Link Warning	0x1806	Invalid position adjustment (Switching Output 1)	The adjustment performed causes the switch points to be outside the sensor nominal range.	Position adjustment + parameter of the hysteresis and window function must be within the sensor nominal range <ul style="list-style-type: none"> ▪ Check position adjustment (see Zero point configuration (ZRO) parameter) ▪ Check the switch point, switchback point for hysteresis and window function
C432	Warning	IO-Link Warning	0x1807	Invalid position adjustment (Switching Output 2)	The adjustment performed causes the switch points to be outside the sensor nominal range.	Position adjustment + parameter of the hysteresis and window function must be within the sensor nominal range <ul style="list-style-type: none"> ▪ Check position adjustment (see Zero point configuration (ZRO) parameter) ▪ Check the switch point, switchback point for hysteresis and window function
F437	Fault	IO-Link Error	0x1810	Incompatible configuration	Invalid device configuration	<ul style="list-style-type: none"> ▪ Restart device ▪ Reset device ▪ Replace device
C469	Fault	IO-Link Error	0x1803	Switch points for output 1 violated	Switch point ≤ switchback point	Check switch points at output
C469	Fault	IO-Link Error	0x1809	Switch points for output 2 violated	Switch point ≤ switchback point	Check switch points at output
C485	Warning	IO-Link Warning	0x8C01 ³⁾	Simulation active	During simulation of the switch output or current output, the device issues a warning message.	Switch off simulation.
S510	Fault	IO-Link Error	0x1802	Turn down violated	A change in the span results in a violation of the turn down (max. TD 5:1) Values for adjustment (lower range value and upper range value) are too close together	<ul style="list-style-type: none"> ▪ Operate device in the specified measuring range ▪ Check the measuring range

Status signal/ Diagnostic event	Diagnostic behavior	IO-Link EventQualifier	EventCode	Event text	Cause	Corrective measure
S803	Fault	IO-Link Error	0x1804	Current loop	Impedance of load resistance at analog output is too high	<ul style="list-style-type: none"> ■ Check the cabling and load at the current output. ■ If the current output is not required, switch the current output off via the configuration. ■ Connect current output with load. ■ If the current output is not required, switch the current output off via the configuration.
F804	Fault	IO-Link Error	0x1808	Overload at switch output 1 or 2	Load current too high	<ul style="list-style-type: none"> ■ Increase load resistance at switch output ■ Check output wiring
F804	Fault	IO-Link Error	0x1808	Overload at switch output 1 or 2	Switch output defective	Replace device
S971	Warning	IO-Link Warning	0x1811	Measured value is outside sensor range	The current is outside the permitted range 3.8 to 20.5 mA. The present pressure value is outside the configured measuring range (but within the sensor range, if applicable).	Operate the device within the set span

- 1) The switch output is open and the current output adopts the configured alarm current. Errors concerning the switch output are not displayed because the switch output is in a safe state.
- 2) If no remedial measures are taken, the warning messages are displayed following a device restart if configuration (span, switch points and offset) is performed with a gauge pressure device and readings are $> URL + 10\%$ or $< LRL + 5\%$ and with an absolute pressure device and readings are $> URL + 10\%$ or $< LRL$.
- 3) EventCode as per IO-Link standard 1.1

10.3 Behavior of the device in the event of a fault





The device displays warnings and faults via I/O-Link. All the device warnings and faults are for information purposes only and do not have a safety function. The errors diagnosed by the device are displayed via IO-Link in accordance with NE107. In accordance with the diagnostic message, the device behaves as per a warning or fault condition. It is necessary to distinguish between the following types of errors here:

- Warning:
 - The device continues measuring if this type of error occurs. The output signal is not affected (exception: simulation is active).
 - The local display alternates between the warning and the main measured value.
 - The switch outputs remain in the state defined by the switch points.
 - The status LED flashes red (not for IO-Link).
 - The background remains white in the event of a warning
- Fault:
 - The device does **not** continue measuring if this type of error occurs. The output signal adopts its fault state (value in the event of an error - see the following section).
 - The fault state is displayed via IO-Link.
 - The fault state is indicated on the local display.
 - The switch outputs assume the "opened" state.
 - For the analog output option, an error is signaled with the configured alarm current behavior.

10.4 Signal on alarm 4 to 20 mA

The response of the output to error is regulated in accordance with NAMUR NE43.

The behavior of the current output in the event of faults is defined in the following parameters:

- Alarm current FCU "MIN": Lower alarm current (≤ 3.6 mA) (optional, see the following table) →  62
 - Alarm current FCU "MAX" (factory setting): Upper alarm current (≥ 21 mA) →  62
 - Alarm current FCU "HLD" (HOLD) (optional, see the following table): Last measured current value is held. When the device starts, the current output is set to "Lower alarm current" (≤ 3.6 mA). →  62
-  ▪ The selected alarm current is used for all errors.
- Errors and warning messages are displayed via IO-Link.
 - Errors and warning messages are displayed only on the primary value page (topmost display level) and are not displayed in the operating menu.
 - In the operating menu the error is only indicated by the color of the display background.
 - The status LED always indicates an error.
 - It is not possible to acknowledge errors and warnings. The relevant message disappears if the event is no longer pending.
 - The failsafe mode can be changed directly when a device is running (see the following table).

Changing the failsafe mode	After confirming with 
from MAX to MIN	active immediately
from MIN to MAX	active immediately
from HLD (HOLD) to MAX	active immediately
from HLD (HOLD) to MIN	active immediately
from MIN to HLD (HOLD)	active outside the fault state
from MAX to HLD (HOLD)	active outside the fault state

10.5 Behavior of the device in the event of a voltage drop

A diagnostic message is not output. The configuration and the settings made are retained.

10.6 Behavior of the device in the event of an incorrect entry

In the case of incorrect entries, the value entered is not accepted. No fault or warning is issued in this case. The value to be adjusted cannot be changed to a value outside the specified limit. This makes it impossible to configure the device using incorrect values. An exception to this is the configuration of the span that results in a violation of the turn down, which in turn gives rise to a fault state.

10.7 Resetting to factory settings (reset)

See Reset to factory settings (RES) parameter description →  71.

11 Maintenance

No special maintenance work is required.

Keep the pressure compensation element (1) free from contamination.

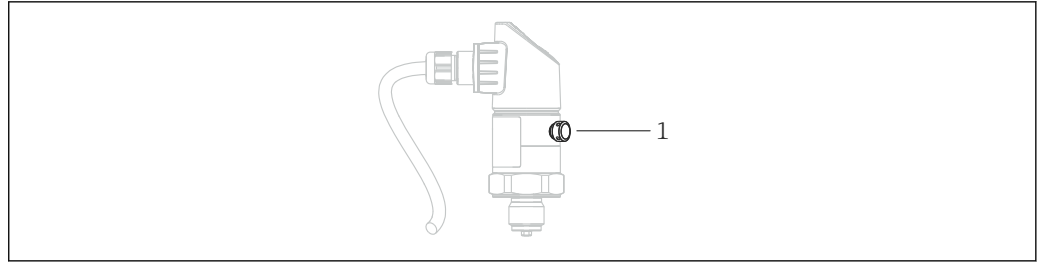

A0022140

11.1 Exterior cleaning

Please note the following points when cleaning the device:

- The cleaning agents used should not corrode the surface and the seals.
- Mechanical damage to the process isolating diaphragm, e.g. due to sharp objects, must be avoided.
- Observe the degree of protection of the device. See the nameplate if necessary → 14.

12 Repairs

12.1 General notes

12.1.1 Repair concept

Repairs are not possible.

12.2 Return

The measuring device must be returned if the wrong device has been ordered or delivered.























As an ISO-certified company and also due to legal regulations, Endress+Hauser is obliged to follow certain procedures when handling any returned products that have been in contact with medium. To ensure swift, safe and professional device returns, please read the return procedures and conditions on the Endress+Hauser website at www.services.endress.com/return-material

12.3 Disposal

When disposing, separate and recycle the device components based on the materials.

13 Overview of the onsite display operating menu

 Depending on the parameter configuration, not all submenus and parameters are available. Information on this can be found in the parameter description under "Prerequisite".

Switch output ¹⁾			Level 0	Level 1	Level 2	Level 3	Description	Details
1 x PNP	2 x PNP	1 x PNP + 4-20 mA						
✓	✓	✓	KYL				If "KYL" is shown on the display, this means that the keys of the device are locked. To unlock the keys, see →  28	
✓	✓	✓	SP1				Switch point value, output 1	→  63
✓	✓	✓	RP1				Switchback point value, output 1	→  63
✓	✓	✓	FH1				Upper value for pressure window, output 1	→  63
✓	✓	✓	FL1				Lower value for pressure window, output 1	→  63
	✓	B ²⁾	SP2				Switch point, output 2	→  65
	✓	B ²⁾	RP2				Switchback point, output 2	→  65
	✓	B ²⁾	FH2				Upper value for pressure window, output 2	→  65
	✓	B ²⁾	FL2				Lower value for pressure window, output 2	→  65
		A ³⁾	STL				Value for 4 mA (LRV)	→  40
		A ³⁾	STU				Value for 20 mA (URV)	→  41
			EF	FUNC			Extended functions	→  40
	✓	✓			OFF			-
		✓			I ⁴⁾			-
	✓	✓			PNP			-
					UNI			→  58
✓	✓	✓			BAR		Unit bar	-
✓	✓	✓			KPA		Unit kPa (depends on the sensor measuring range)	-
✓	✓	✓			MPA		Unit MPa (depends on the sensor measuring range)	-
✓	✓	✓			PSI		Unit psi	-
✓	✓	✓			ZRO		Zero point configuration	→  38
✓	✓	✓			GTZ		Zero point adoption	→  38
✓	✓	✓			TAU		Damping	→  60
		A ³⁾			I		Current output	-
					GTL		Pressure applied for 4mA (LRV)	→  41
					GTU		Pressure applied for 20mA (URV)	→  42
					FCU		Alarm current	→  62
		A ³⁾			MIN		In the event of an error: MIN (≤3.6 mA)	-
		A ³⁾			MAX		In the event of an error: MAX (≥21 mA)	-
		A ³⁾			HLD		Last current value (HOLD)	-
✓	✓	✓			dS1		Switching delay time, output 1	→  67
✓	✓	✓			dR1		Switchback delay time, output 1	→  67
					Ou1		Output 1	-
✓	✓	✓			HNO		NO contact for hysteresis function	→  70
✓	✓	✓			HNC		NC contact for hysteresis function	→  70





























Switch output ¹⁾			Level 0	Level 1	Level 2	Level 3	Description	Details
1 x PNP	2 x PNP	1 x PNP + 4-20 mA						
✓	✓	✓			FNO		NO contact for window function	→ ⓘ 70
✓	✓	✓			FNC		NC contact for window function	→ ⓘ 70
	✓	B ²⁾			dS2		Switching delay time, output 2	→ ⓘ 68
	✓	B ²⁾			dR2		Switchback delay time, output 2	→ ⓘ 68
					Ou2		Output 2	-
	✓	B ²⁾			HNO		NO contact for hysteresis function	→ ⓘ 70
	✓	B ²⁾			HNC		NC contact for hysteresis function	→ ⓘ 70
	✓	B ²⁾			FNO		NO contact for window function	→ ⓘ 70
	✓	B ²⁾			FNC		NC contact for window function	→ ⓘ 70
✓	✓	✓			HI		Max value (maximum indicator)	→ ⓘ 70
✓	✓	✓			LO		Min value (minimum indicator)	→ ⓘ 71
✓	✓	✓			RVC		Revision counter	→ ⓘ 71
✓	✓	✓			RES		Reset	→ ⓘ 71
					ADM		Administration	-
✓	✓	✓			LCK		Unlocking code	→ ⓘ 72
✓	✓	✓			COD		Locking code	→ ⓘ 72
					DIS		Display	-
✓	✓	✓			DVA	PV	Display measured value	→ ⓘ 73
		A ³⁾				PV/,	Display the measured value as a percentage of the set span	-
✓	✓	✓				SP	Display set switch point	-
✓	✓	✓			DRO		Display measured value rotated by 180°	→ ⓘ 73
✓	✓	✓			DOF		Display off	→ ⓘ 73
					DIAG		Diagnosis	-
✓	✓	✓			STA		Current device status	→ ⓘ 56
✓	✓	✓			LST		Last device status	→ ⓘ 56
					SM1		Simulation output 1	→ ⓘ 56
✓	✓	✓			OFF			-
✓	✓	✓			OPN		Switch output opened	-
✓	✓	✓			CLS		Switch output closed	-
					SM2 ⁵⁾		Simulation output 2	→ ⓘ 58
							Current output simulation	→ ⓘ 57
	✓	✓			OFF			-
	✓	B ²⁾			OPN		Switch output opened	-
	✓	B ²⁾			CLS		Switch output closed	-
		A ³⁾			3.5		Simulation value for analog output in mA	-
		A ³⁾			4		Simulation value for analog output in mA	-
		A ³⁾			8		Simulation value for analog output in mA	-
		A ³⁾			12		Simulation value for analog output in mA	-
		A ³⁾			16		Simulation value for analog output in mA	-















Switch output ¹⁾			Level 0	Level 1	Level 2	Level 3	Description	Details
1 x PNP	2 x PNP	1 x PNP + 4-20 mA						
		A ³⁾			20		Simulation value for analog output in mA	-
		A ³⁾			21.95		Simulation value for analog output in mA	-

- 1) The assignment of the outputs cannot be modified.
- 2) B = Functionality is active if "PNP" has been configured in the "FUNC" menu.
- 3) A = Functionality is active if "I" has been configured in the "FUNC" menu.
- 4) I can only be selected if the device has been ordered with 4-20 mA.
- 5) For devices with a 4-20 mA current output: can only be selected if the output is switched on.

14 Overview of the IO-Link operating menu

 Depending on the parameter configuration, not all submenus and parameters are available. Information on this can be found in the parameter description under "Prerequisite".

Level 0	Level 1	Level 2	Level 3	Details
Identification	Serial number			-
	Firmware version			-
	Extended Ordercode			→  56
	ProductName			-
	ProductText			-
	VendorName			-
	VendorText			-
	Hardware revision			-
	ENP_VERSION			→  56
	Application Specific Tag			→  56
	Device Type			-
Diagnosis	Actual Diagnostics (STA)			→  56
	Last Diagnostic (LST)			→  56
	Simulation Switch Output (OU1)			→  56
	Simulation Current Output (OU2)			→  57
	Simulation Switch Output (OU2)			→  58
	Device Search			→  57
Parameter	Application	Sensor	Operating Mode (FUNC)	→  40
			Unit changeover (UNI)	→  58
			Zero point configuration (ZRO)	→  38
			Zero point adoption (GTZ)	→  38
			Damping (TAU)	→  60
	Current output		Value for 4 mA (STL)	→  40
			Value for 20 mA (STU)	→  41
			Pressure applied for 4mA (GTL)	→  41
			Pressure applied for 20mA (GTU)	→  42
			Alarm current (FCU)	→  62
	Switch output 1		Switch point value / Upper value for pressure window, output 1 (SP1 / FH1)	→  63
			Switchback point value / Lower value for pressure window, output 1 (RP1 / FL1)	→  63
			Switching delay time, output 1 (dS1)	→  67
			Switchback delay time, output 1 (dR1)	→  67
			Output 1 (OU1)	→  70
	Switch output 2		Switch point value / Upper value for pressure window, output 2 (SP2 / FH2)	→  65
			Switchback point value / Lower value for pressure window, output 2 (RP2 / FL2)	→  65
			Switching delay time, output 2 (dS2)	→  68
			Switchback delay time, output 2 (dR2)	→  68
			Output 2 (OU2)	→  70

Level 0	Level 1	Level 2	Level 3	Details
	System	Device Management	Hi Max value (maximum indicator)	→  70
			Lo Min value (minimum indicator)	→  71
			Revisioncounter (RVC)	→  71
			Reset to factory settings (RES)	→  71
			Device Access Locks.Data Storage Lock	→  72
		User Administration (ADM)	unlocking code (LCK)	→  72
			locking code (COD)	→  72
			Device Access Lock.Local Parametrization Lock	→  73
		Display (DIS)	Measured value display (DVA)	→  73
			Display measured value rotated by 180° (DRO)	→  73
			Switch display on or off (DOF)	→  73
Observation	Pressure		→  74	
	Switch State Output (Ou1)		→  74	
	Switch State Output (Ou2)		→  74	

15 Description of device parameters

Extended Ordercode

Navigation	IO-Link: Identification → Extended Ordercode
Description	Used to replace the device. Displays the extended order code (max. 60 alphanumeric characters).
Factory setting	As per order specifications

ENP_VERSION

Navigation	IO-Link: Identification → ENP_VERSION
Description	Displays the ENP version (ENP: electronic name plate)

Application Specific Tag

Navigation	IO-Link: Identification → Application Specific Tag
Description	Used for unique identification of device in the field. Enter device tag (max. 32 alphanumeric characters).
Factory setting	As per order specifications

Actual Diagnostics (STA)

Navigation	Display: DIAG → Actual Diagnostics (STA) IO-Link: Diagnosis → Actual Diagnostics (STA)
Description	Displays the current device status.

Last Diagnostic (LST)

Navigation	Display: DIAG → Last Diagnostic (LST) IO-Link: Diagnosis → Last Diagnostic (LST)
Description	Displays the latest device status (error or warning) that was rectified during operation.

Simulation Switch Output (OU1)

Navigation Display: DIAG → SM1 → Simulation Switch Output (OU1)
IO-Link: Diagnosis → Simulation Switch Output (OU1)

Description  When IO-Link communication is active, the simulation affects the process data only. It does not affect the physical switch output.

If a simulation is active, a warning to this effect is displayed so that it is obvious to the user that the device is in the simulation mode. A visual warning is indicated on the local display (C485 - Simulation active) and a warning is communicated via IO-Link (C485 - Simulation active). The simulation must be ended actively via the menu. If the device is disconnected from the power supply during the simulation and power is then resupplied, the simulation mode is not resumed, and instead the device continues operation in the measuring mode.

Options

- OFF
- OPN (switch output open)
- CLS (switch output closed)

Simulation Current Output (OU2)

Navigation Display: Diag → SM2 → Simulation Current Output (OU2)
IO-Link: Diagnosis → Simulation Current Output (OU2)

Description Simulation affects the process data and the physical current output.

If a simulation is active, a warning to this effect is displayed so that it is obvious to the user that the device is in the simulation mode. A warning is communicated via IO-Link (C485 - simulation active). The simulation must be ended actively via the menu. If the device is disconnected from the power supply during the simulation and then power is resupplied afterwards, the simulation mode is not resumed, and instead the device continues operation in the measuring mode.

Options

- OFF
- 3.5 mA
- 4 mA
- 8 mA
- 12 mA
- 16 mA
- 20 mA
- 21.95 mA

Device Search

Navigation IO-Link: Diagnosis → Device Search

Description This parameter is used to uniquely identify the device during installation. The green LED is lit (= operational) on the device and starts to flash with increased luminosity.

Options

- OFF
- ON

Factory setting OFF

Simulation Switch Output (OU2) Simulation output 2 (for devices with 2 switch outputs)

Navigation	Display: DIAG → Simulation Switch Output (OU2) IO-Link: Diagnosis → Simulation Switch Output (OU2)
Description	Switch output simulation. If a simulation is active, a warning to this effect is displayed so that it is obvious to the user that the device is in the simulation mode. A visual warning is indicated on the local display (C485 - Simulation Active). The simulation must be ended actively via the menu. If the device is disconnected from the power supply during the simulation and then power is resupplied afterwards, the simulation mode is not resumed, and instead the device continues operation in the measuring mode.
Options	<ul style="list-style-type: none"> ■ OFF ■ OPN (switch output open) ■ CLS (switch output closed)

Operating Mode (FUNC)

Navigation	Display: EF → Operating Mode (FUNC) IO-Link: Parameter → Application → Sensor → Operating Mode (FUNC)
Description	Enables the desired behavior of output 2 (not IO-Link output)
Options	Options: <ul style="list-style-type: none"> ■ OFF ■ 4-20 mA (I) ((can only be selected if the device has been ordered with 4-20mA)) ■ DC-PNP (PNP)

Unit changeover (UNI)

Navigation	Display: EF → Unit changeover (UNI) IO-Link: Parameter → Application → Sensor → Unit changeover (UNI)
Description	Select the pressure engineering unit. If a new pressure engineering unit is selected, all pressure-specific parameters are converted.
Options	<ul style="list-style-type: none"> ■ bar ■ kPa ■ Mpa ■ psi
Factory setting	Depends on order specifications.

Zero point configuration (ZRO)

Navigation	Display: EF → Zero point configuration (ZRO) IO-Link: Parameter → Application → Sensor → Zero point configuration (ZRO)
Description	(typically absolute pressure sensor) The pressure resulting from the orientation of the device can be corrected here. The pressure difference between zero (set point) and the measured pressure must be known.
Prerequisite	An offset is possible (parallel shifting of the sensor characteristic) to correct the orientation and any zero point drift. The set value of the parameter is subtracted from the "raw measured value". The requirement to be able to perform a zero point shift without changing the span is met with the offset function. Maximum offset value = ± 20 % of the sensor nominal range. If an offset value is entered that shifts the span beyond the physical limits of the sensor, the value is admitted but a warning message is generated and displayed via IO-Link. The warning message only disappears when the span is within the sensor limits, taking the offset value currently configured into consideration. The sensor can <ul style="list-style-type: none"> ■ be operated in a physically unfavorable range, i.e. outside its specifications, or ■ be operated by making appropriate corrections to the offset or span. Raw measured value – (manual offset) = display value (measured value)
Example	<ul style="list-style-type: none"> ■ Measured value = 0.002 mbar (0.029 psi) ■ Set the measured value in the parameter to 0.002. ■ Measured value (after pos. zero adjust) = 0.000 mbar (0 psi) ■ The current value is also corrected.
Note	Setting in increments of 0.001. As the value is entered numerically, the increment depends on the measuring range
Options	No selection. The user is free to edit the values.
Factory setting	0

Zero point adoption (GTZ)

Navigation	Display: EF → Zero point adoption (GTZ) IO-Link: Parameter → Application → Sensor → Zero point adoption (GTZ)
Description	(typically gauge pressure sensor) The pressure resulting from the orientation of the device can be corrected here. The pressure difference between zero (set point) and the measured pressure need not be known.

Prerequisite

The pressure value present is automatically adopted as the zero point. An offset is possible (parallel shifting of the sensor characteristic) to correct the orientation and any zero point drift. The accepted value of the parameter is subtracted from the "raw measured value". The requirement to be able to perform a zero point shift without changing the span is met with the offset function. Maximum offset value = $\pm 20\%$ of the sensor nominal range. If an offset value is entered that shifts the span beyond the physical limits of the sensor, the value is admitted but a warning message is generated and displayed via IO-Link. The warning message only disappears when the span is within the sensor limits, taking the offset value currently configured into consideration.

The sensor can

- be operated in a physically unfavorable range, i.e. outside its specifications, or
- be operated by making appropriate corrections to the offset or span.

Raw measured value – (manual offset) = display value (measured value)

Example 1

- Measured value = 0.002 mbar (0.029 psi)
- Use the **Zero point adoption (GTZ)** parameter to correct the measured value with the value, e.g. 0.002 mbar (0.029 psi). This means that you are assigning the value 0.000 (0 psi) to the pressure present.
- Measured value (after pos. zero adjust) = 0.000 mbar (0 psi)
- The current value is also corrected.
- Where applicable, check and correct switch points and span settings.

Example 2

Sensor measuring range: -0.4 to +0.4 bar (-6 to +6 psi) (SP1 = 0.4 bar (6 psi); STU = 0.4 bar (6 psi))

- Measured value = 0.08 bar (1.2 psi)
- Use the **Zero point adoption (GTZ)** parameter to correct the measured value with the value, e.g. 0.08 bar (1.2 psi). This means that you are assigning the value 0 mbar (0 psi) to the pressure present.
- Measured value (after pos. zero adjust) = 0 mbar (0 psi)
- The current value is also corrected.
- Warnings C431 or C432 appear because the value 0 bar (0 psi) was assigned to the real value of 0.08 bar (1.2 psi) present and the sensor measuring range was thus exceeded by $\pm 20\%$.
SP1 and STU values must be readjusted downwards by 0.08 bar (1.2 psi).

Damping (TAU)

Navigation

Display: EF → Damping (TAU)
IO-Link: Parameter → Application → Sensor → Damping (TAU)

Description

The damping affects the speed at which the measured value reacts to changes in pressure.

Input range

0.0 to 999.9 seconds in increments of 0.1 seconds

Factory setting

2 seconds

Value for 4 mA (STL)

Navigation

Display: STL → Value for 4 mA (STL)
IO-Link: Parameter → Application → Current output → Value for 4 mA (STL)

Description	Assignment of the pressure value which should correspond to the 4 mA value. It is possible to invert the current output. To do so, assign the pressure upper range value to the lower measuring current.
Note	Enter the value for 4 mA in the selected pressure unit anywhere within the measuring range. The value can be entered in increments of 0.1 (increment depends on the measuring range).
Options	No selection. The user is free to edit the values.
Factory setting	0.0 or as per order specifications

Value for 20 mA (STU)

Navigation	Display: STU → Value for 20 mA (STU) IO-Link: Parameter → Application → Current output → Value for 20 mA (STU)
Description	Assignment of the pressure value which should correspond to the 20 mA value. It is possible to invert the current output. To do so, assign the pressure lower range value to the upper measuring current.
Note	Enter the value for 20 mA in the selected pressure unit anywhere within the measuring range. The value can be entered in increments of 0.1 (increment depends on the measuring range).
Options	No selection. The user is free to edit the values.
Factory setting	Upper measuring limit or as per order specifications.

Pressure applied for 4mA (GTL)

Navigation	Display: EF → I → Pressure applied for 4mA (GTL) IO-Link: Parameter → Application → Current output → Pressure applied for 4mA (GTL)
-------------------	--

Description

The pressure value present is automatically adopted for the 4 mA current signal. Parameter for which the current range can be assigned to any section of the nominal range. This occurs by assigning the pressure lower range value to the lower measuring current and the pressure upper range value to the upper measuring current. The pressure lower range value and upper range value can be configured independently of one another so the pressure measuring span does not remain constant. The LRV and URV pressure measuring span can be edited over the entire sensor range. An invalid TD value is indicated by diagnostic message S510. An invalid position offset is indicated by diagnostic message C431. The editing operation cannot result in the device being operated outside the minimum and maximum sensor limits.

Incorrect entries are declined as indicated by the following messages, and the last valid value prior to the change is used again:

- Parameter value above limit (0x8031)
- Parameter value below limit (0x8032)

The measured value currently present is accepted as the value for 4mA anywhere within the measuring range. The sensor characteristic curve is shifted such that the pressure present becomes the zero value.

Pressure applied for 20mA (GTU)

Navigation

Display: EF → I → Pressure applied for 20mA (GTU)
 IO-Link: Parameter → Application → Current output → Pressure applied for 20mA (GTU)

Description

The pressure value present is automatically adopted for the 20 mA current signal. Parameter for which the current range can be assigned to any section of the nominal range. This occurs by assigning the pressure lower range value to the lower measuring current and the pressure upper range value to the upper measuring current. The pressure lower range value and upper range value can be configured independently of one another so the pressure measuring span does not remain constant. The LRV and URV pressure measuring span can be edited over the entire sensor range. An invalid TD value is indicated by diagnostic message S510. An invalid position offset is indicated by diagnostic message C431. The editing operation cannot result in the device being operated outside the minimum and maximum sensor limits. Incorrect entries are declined, and the last valid value prior to the change is used again. The measured value currently present is accepted as the value for 20 mA anywhere within the measuring range. There is a parallel shift of the sensor characteristic so that the pressure present becomes the max value.

Alarm current (FCU)

Navigation

Display: EF → I → Alarm current (FCU)
 IO-Link: Parameter → Application → Current output (OU2) → Alarm current (FCU)

Description	<p>The device displays warnings and faults. This is done via IO-Link using the diagnostic message stored in the device. The purpose of all device diagnostics is solely to provide information to the user; they do not have a safety function. The errors diagnosed by the device are displayed via IO-Link in accordance with NE107. In accordance with the diagnostic message, the device behaves as per a warning or fault condition:</p> <p>Warning (S971, S140, C485, C431, C432): With this type of error, the device continues to measure. The output signal does not adopt its fault state (value in the event of an error). The main measured value and the state in the form of the letter plus a defined number are displayed alternately (0.5 Hz) via IO-Link. The switch outputs remain in the state defined by the switch points.</p> <p>Fault (F437, S803, F270, S510, C469, F804): With this type of error, the device does not continue to measure. The output signal adopts its fault state (value in the event of an error). The fault state is displayed via IO-Link in the form of the letter plus a defined number. The switch output changes to the defined state (open). For the analog output option, an error is also signaled and transmitted via the 4 to 20mA signal. In NE43, NAMUR defines a current ≤ 3.6 mA and ≥ 21 mA as a device failure. A corresponding diagnostic message is displayed. Current levels available for selection: The selected alarm current is used for all errors. Diagnostic messages are displayed with numbers and letter via IO-Link. It is not possible to acknowledge all the diagnostic messages. The relevant message disappears if the event is no longer pending.</p> <p>The messages are displayed in order of priority:</p> <ul style="list-style-type: none"> ■ Highest priority = first message displayed ■ Lowest priority = last message displayed
Options	<ul style="list-style-type: none"> ■ Min: Lower alarm current (≤ 3.6 mA) ■ Max: Upper alarm current (≥ 21 mA)
Factory setting	Max or as per order specifications

Switch point value / Upper value for pressure window, output 1 (SP1 / FH1)
Switchback point value / Lower value for pressure window, output 1 (RP1 / FL1)

Navigation	<p>Display: SP1 / FH1 / RP1 / FL1 → Switch point value.../Switchback point value... IO-Link: Parameter → Application → Switch output (OU1) → Switch point value.../Switchback point value...</p>
Prerequisite	<p>The following functions are available only if a hysteresis function has been configured for the switch output (output 1 (Ou1)).</p>
Description of behavior of SP1 / RP1	<p>The hysteresis is implemented using the SP1 and RP1 parameters. Since the parameter settings depend on one another, the parameters are described all together.</p> <p>The switch point "SP1" and switchback point "RP1" can be defined with these functions (e.g. for pump control). When the set switch point "SP1" is reached (with increasing pressure), an electrical signal change takes place at the switch output. When the set switchback point "RP1" is reached (with decreasing pressure), an electrical signal change takes place at the switch output. The difference between the value of switch point "SP1" and the value of switchback point "RP1" is known as the hysteresis. The configured value for the switch point "SP1" must be greater than the switchback point "RP1"! A diagnostic message is displayed if a switch point "SP1" is entered that is \leq the switchback point "RP1". While it is possible to make this entry, it does not take effect in the device. The entry must be corrected!</p>

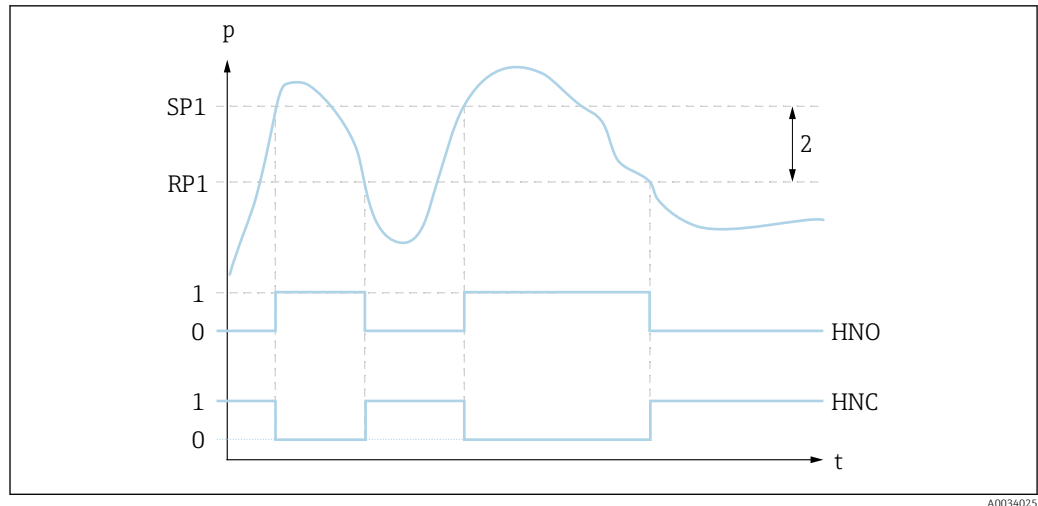

A0034025

- 0 0-signal. Output open in quiescent state.
- 1 1-signal. Output closed in quiescent state.
- 2 Hysteresis
- SP1 Switch point
- RP1 Switchback point
- HNO NO contact
- HNC NC contact

i To prevent switch-on and switch-off if values are around the switch point "SP1" or switchback point "RP1", a delay can be set for the relevant points. In this regard, see the **Switching delay time, output 1 (dS1)** and **Switchback delay time, output 1 (dR1)** parameter descriptions.

Prerequisite The following functions are available only if a window function has been configured for the switch output (output 1 (Ou1)).

Description of behavior of FH1 / FL1 The window function is implemented using the **FH1** and **FL1** parameters. Since the parameter settings depend on one another, the parameters are described all together. The upper value of the pressure window "FH1" and the lower value of the pressure window "FL1" can be defined with these functions (e.g. for monitoring a certain pressure range). When the lower value of the pressure window "FL1" is reached (with increasing or decreasing pressure), an electrical signal change takes place at the switch output. When the upper value of the pressure window "FH1" is reached (with increasing or decreasing pressure), an electrical signal change takes place at the switch output. The difference between the upper value of the pressure window "FH1" and the lower value of the pressure window "FL1" is known as the pressure window. The upper value of the pressure window "FH1" must be greater than the lower value of the pressure window "FL1"! A diagnostic message is displayed if the upper value entered for the pressure window "FH1" is less than the lower value of the pressure window "FL1". While it is possible to make this entry, it does not take effect in the device. The entry must be corrected!

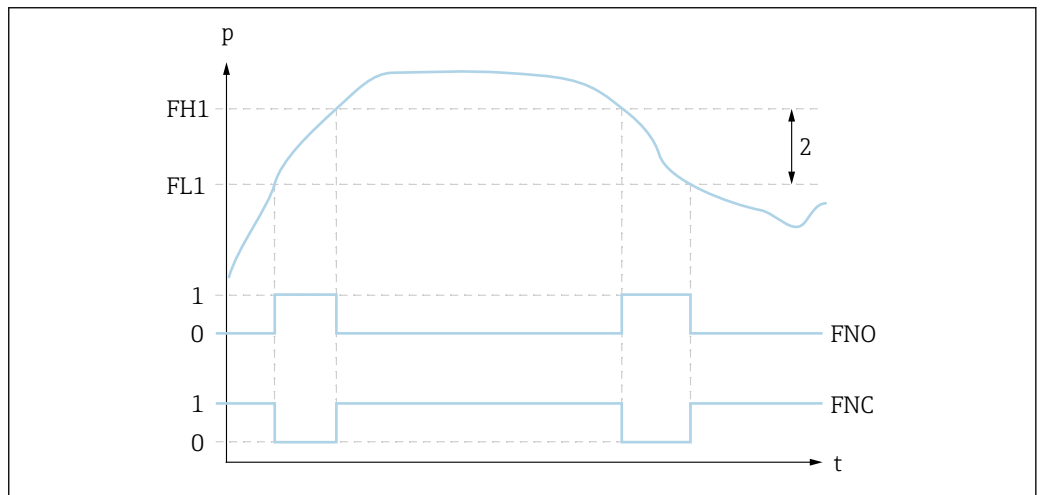

A0034026

- 0 0-signal. Output open in quiescent state.
- 1 1-signal. Output closed in quiescent state.
- 2 Pressure window (difference between the value of the high window "FH1" and the low window "FL1")
- FNO NO contact
- FNC NC contact
- FH1 Upper value of the pressure window
- FL1 Lower value of the pressure window

Options No selection. The user is free to edit the values.

Factory setting Factory setting (if no customer-specific setting is ordered):
Switch point SP1 / FH1: 90%; switchback point RP1 / FL1: 10%

Switch point value / Upper value for pressure window, output 2 (SP2 / FH2)
Switchback point value / Lower value for pressure window, output 2 (RP2 / FL2)

Navigation Display: SP2 / FH2 / RP2 / FL2 → Switch point value.../Switchback point value...
IO-Link: Parameter → Application → Switch output (OU2) → Switch point value.../Switchback point value...

Prerequisite The following functions are available only if a hysteresis function has been configured for the switch output (output 2 (Ou2)).

Description of behavior of SP2 / RP2

The hysteresis is implemented using the **SP2** and **RP2** parameters. Since the parameter settings depend on one another, the parameters are described all together. The switch point "SP2" and switchback point "RP2" can be defined with these functions (e.g. for pump control). When the set switch point "SP2" is reached (with increasing pressure), an electrical signal change takes place at the switch output. When the set switchback point "RP2" is reached (with decreasing pressure), an electrical signal change takes place at the switch output. The difference between the value of the switch point "SP2" and the switchback point "RP2" is known as the hysteresis. The configured value for the switch point "SP2" must be greater than the switchback point "RP2"! A diagnostic message is displayed if a switch point "SP2" is entered that is \leq the switchback point "RP2". While it is possible to make this entry, it does not take effect in the device. The entry must be corrected!

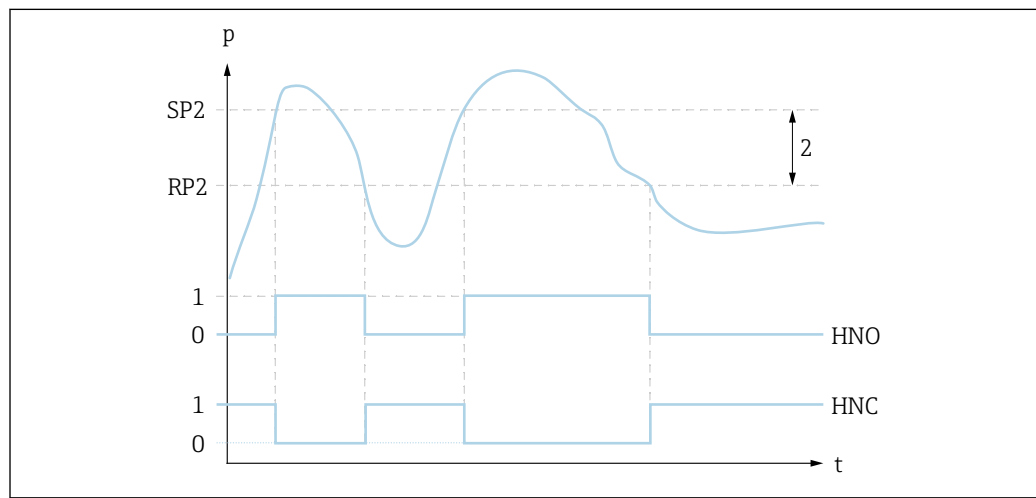

A0037011

- 0 0-signal. Output open in quiescent state.
- 1 1-signal. Output closed in quiescent state.
- 2 Hysteresis
- SP2 Switch point
- RP2 Switchback point
- HNO NO contact
- HNC NC contact

i To prevent switch-on and switch-off if values are around the switch point "SP2" or switchback point "RP2", a delay can be set for the relevant points. In this regard, see the **Switching delay time, output 2 (dS2)** and **Switchback delay time, output 2 (dR2)** parameter descriptions.

Prerequisite

The following functions are available only if a window function has been configured for the switch output (output 2 (Ou2)).

Description of behavior of FH2 / FL2

The window function is implemented using the **FH2** and **FL2** parameters. Since the parameter settings depend on one another, the parameters are described all together. The upper value of the pressure window "FH2" and the lower value of the pressure window "FL2" can be defined with these functions (e.g. for monitoring a certain pressure range). When the lower value of the pressure window "FL2" is reached (with increasing or decreasing pressure), an electrical signal change takes place at the switch output. When the upper value of the pressure window "FH2" is reached (with increasing or decreasing pressure), an electrical signal change takes place at the switch output. The difference between the upper value of the pressure window "FH2" and the lower value of the pressure window "FL2" is known as the pressure window. The upper value of the pressure window "FH2" must be greater than the lower value of the pressure window "FL2"! A diagnostic message is displayed if the upper value entered for the pressure window "FH2" is less than the lower value of the pressure window "FL2". While it is possible to make this entry, it does not take effect in the device. The entry must be corrected!

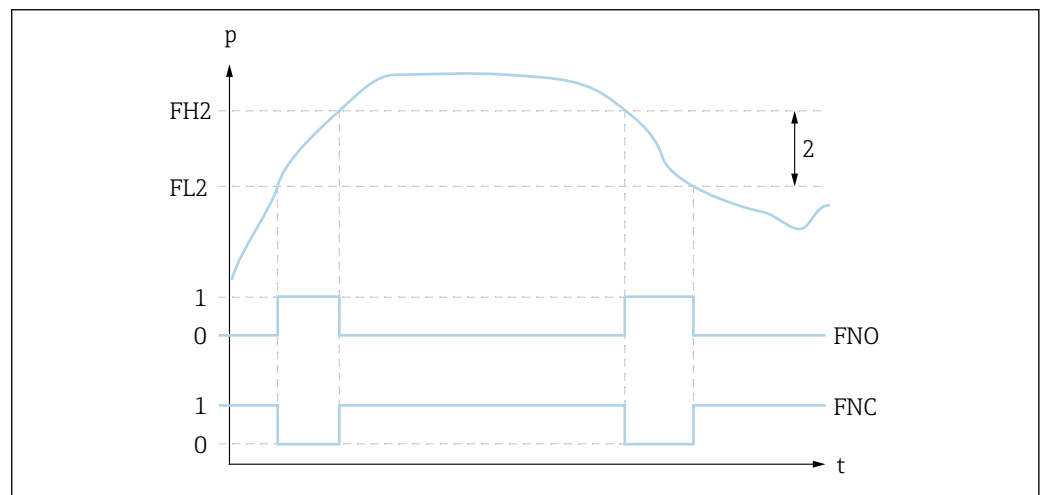

A0037012

- 0 0-signal. Output open in quiescent state.
- 1 1-signal. Output closed in quiescent state.
- 2 Pressure window (difference between the value of the high window "FH2" and the low window "FL2")
- FNO NO contact
- FNC NC contact
- FH2 Upper value of the pressure window
- FL2 Lower value of the pressure window

Options

No selection. The user is free to edit the values.

Factory setting

Factory setting (if no customer-specific setting is ordered):
 Switch point SP2 / FH2: 90%; switchback point RP2 / FL2: 10%

Switching delay time, output 1 (dS1)
Switchback delay time, output 1 (dR1)

Note

The switching delay time/switchback delay time function is implemented using the **dS1** and **dR1** parameters. Since the parameter settings depend on one another, the parameters are described all together.

- dS1 = switching delay time, output 1
- dR1 = switchback delay time, output 1

Navigation

Display: EF → Switching delay.../Switchback delay...

IO-Link: Parameter → Application → Switch output (OU1) → Switching delay.../Switchback delay...

Description

To prevent switch-on and switch-off if values are around the switch point "SP1" or the switchback point "RP1", a delay in a range of 0 – 50 seconds, to two decimal places, can be set for the individual points.

If the measured value leaves the switching range during the delay time, the delay time starts again from scratch.

Example

- SP1 = 2 bar (29 psi)
- RP1 = 1 bar (14.5 psi)
- dS1 = 5 seconds
- dR1 = 2 seconds

dS1/: ≥ 2 bar (29 psi) must be present for at least 5 seconds for SP1 to become active.

dR1/: ≥ 1 bar (14.5 psi) must be present for at least 2 seconds for RP1 to become active.

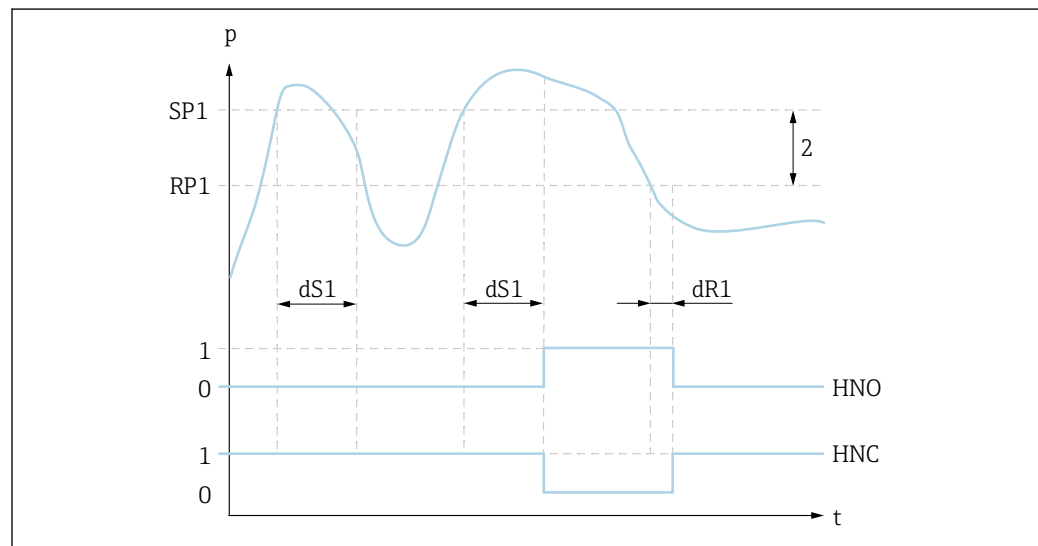

A0034027

0 0-signal. Output open in quiescent state.

1 1-signal. Output closed in quiescent state.

2 Hysteresis (difference between the value of the switch point "SP1" and the value of the switchback point "RP1")

HNO NO contact

HNC NC contact

SP1 Switch point 1

RP1 Switchback point 1

dS1 Set time for which the specific switch point must be reached continuously without interruption until an electrical signal change takes place.

dR1 Set time for which the specific switchback point must be reached continuously without interruption until an electrical signal change takes place.

Input range

0.00 - 50.00 seconds

Factory setting

0

Switching delay time, output 2 (dS2)
Switchback delay time, output 2 (dR2)

Note The switching delay time/switchback delay time function is implemented using the **dS2** and **dR2** parameters. Since the parameter settings depend on one another, the parameters are described all together.

- dS2 = switching delay time, output 2
- dR2 = switchback delay time, output 2

Navigation Display: EF → Switching delay.../Switchback delay...
 IO-Link: Parameter → Application → Switch output (OU2) → Switching delay.../Switchback delay...

Description To prevent switch-on and switch-off if values are around the switch point "SP2" or the switchback point "RP2", a delay in a range of 0 – 50 seconds, to two decimal places, can be set for the individual points.
 If the measured value leaves the switching range during the delay time, the delay time starts again from scratch.

- Example**
- SP2 = 2 bar (29 psi)
 - RP2 = 1 bar (14.5 psi)
 - dS2 = 5 seconds
 - dR2 = 2 seconds

dS2/: ≥ 2 bar (29 psi) must be present for at least 5 seconds for SP2 to become active.
 dR2/: ≥ 1 bar (14.5 psi) must be present for at least 2 seconds for RP2 to become active.

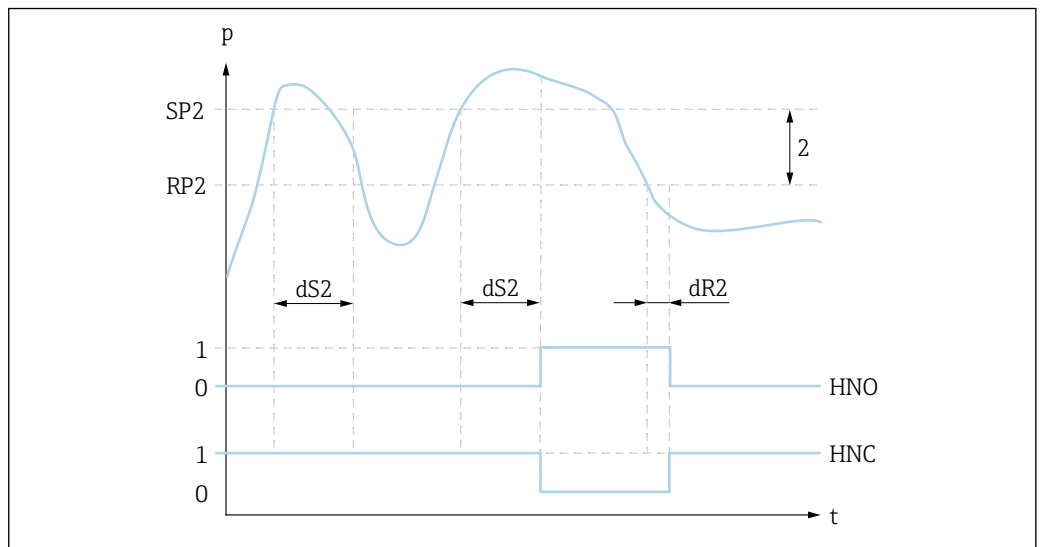

A0037013

- 0 0-signal. Output open in quiescent state.
- 1 1-signal. Output closed in quiescent state.
- 2 Hysteresis (difference between the value of the switch point "SP2" and the value of the switchback point "RP2")
- HNO NO contact
- HNC NC contact
- SP2 Switch point 2
- RP2 Switchback point 2
- dS2 Set time for which the specific switch point must be reached continuously without interruption until an electrical signal change takes place.
- dR2 Set time for which the specific switchback point must be reached continuously without interruption until an electrical signal change takes place.

Input range 0.00 - 50.00 seconds

Factory setting 0

Output 1 (OU1)

Navigation	Display: EF → Output 1 (OU1) IO-Link: Parameter → Application → Switch output (OU1) → Output 1 (OU1)
Description	<ul style="list-style-type: none"> ■ Hysteresis normally open (HNO): The switch output is specified as a NO contact with hysteresis properties. ■ Hysteresis normally closed (HNC): The switch output is specified as an NC contact with hysteresis properties. ■ Window normally open (FNO): The switch output is specified as a NO contact with window properties. ■ Window normally closed (FNC): The switch output is specified as an NC contact with window properties.
Options	<ul style="list-style-type: none"> ■ Hysteresis normally open (HNO) ■ Hysteresis normally closed (HNC) ■ Window normally open (FNO) ■ Window normally closed (FNC)
Factory setting	Hysteresis normally open (HNO) or as per order specifications

Output 2 (OU2)

Navigation	Display: EF → Output 2 (OU2) IO-Link: Parameter → Application → Switch output (OU2) → Output 2 (OU2)
Description	<ul style="list-style-type: none"> ■ Hysteresis normally open (HNO): The switch output is specified as a NO contact with hysteresis properties. ■ Hysteresis normally closed (HNC): The switch output is specified as an NC contact with hysteresis properties. ■ Window normally open (FNO): The switch output is specified as a NO contact with window properties. ■ Window normally closed (FNC): The switch output is specified as an NC contact with window properties.
Options	<ul style="list-style-type: none"> ■ Hysteresis normally open (HNO) ■ Hysteresis normally closed (HNC) ■ Window normally open (FNO) ■ Window normally closed (FNC)
Factory setting	Hysteresis normally closed (HNC) or as per order specifications

Display: HI
IO-Link: HI Max value (maximum indicator)

Navigation	Display: EF → I → HI IO-Link: Parameter → System → Device Management → HI Max value (maximum indicator)
-------------------	--

Description This parameter is used as the maximum indicator and makes it possible to call up retroactively the highest value ever measured for pressure.
A pressure that is present for at least 2.5 ms is logged to the maximum indicator.
The maximum indicators cannot be reset.

Display: LO
IO-Link: LO Min value (minimum indicator)

Navigation Display: EF → I → LO
IO-Link: Parameter → System → Device Management → LO Min value (minimum indicator)

Description This parameter is used as the maximum indicator and makes it possible to call up retroactively the lowest value ever measured for pressure.
A pressure that is present for at least 2.5 ms is logged to the maximum indicator.
The maximum indicators cannot be reset.

Revisioncounter (RVC)

Navigation Display: EF → I → Revisioncounter (RVC)
IO-Link: Parameter → System → Device Management → Revisioncounter (RVC)

Description Counter that indicates the number of parameter changes.

Reset to factory settings (RES)

Navigation Display: EF → I → Reset to factory settings (RES)
IO-Link: Parameter → System → Device Management → Reset to factory settings (RES)

Description **⚠ WARNING**
Confirming the "Standard Command" with "Reset to factory settings" causes an immediate reset to the factory settings of the order configuration.
If the factory settings have been changed, downstream processes might be affected following a reset (the behavior of the switch output or current output might be changed).

- ▶ Make sure that downstream processes are not started unintentionally.

The reset is not subject to additional locking, such as in the form of device locking. The reset also depends on the device status.

Any customer-specific configuration carried out at the factory is not affected by a reset (customer-specific configuration remains).

The following parameters are not reset when a reset is performed:

- LO Min value (minimum indicator)
- HI Max value (maximum indicator)
- Last Diagnostic (LST)
- Revisioncounter (RVC)

Device Access Locks.Data Storage Lock ¹⁾ Activation/deactivation of DataStorage

1) The "Device Access Locks.Data Storage Lock" parameter is an IO-Link standard parameter. The name of the parameter may be available in the language configured in the IO-Link operating tool that is used. The display depends on the particular operating tool.

Navigation	IO-Link: Parameter → System → User Administration (ADM) → Device Access Locks.Data Storage Lock
Description	The device supports DataStorage. If a device is being replaced, this allows the configuration of the old device to be written to the new device. If, when a device is being replaced, the original configuration of the new device is to be retained, the Device Access Locks.Data Storage Lock parameter can be used to prevent the parameters from being overwritten. If this parameter is set to "true", the new device does not adopt the data stored in the master's DataStorage.
Options	<ul style="list-style-type: none"> ■ false ■ true

LCK unlocking code

Navigation	Display: EF → ADM → LCK IO-Link: Parameter → System → User Administration (ADM) → LCK
Description	The device is unlocked by entering the code defined in COD.
Input range	0000-9999
Note	If parameters are locked, the word "LCK" appears on the local display as soon as an attempt is made to change a parameter. Locking is enabled again after 60 seconds in the measured value display and following a device restart.

COD locking code

Navigation	Display: EF → ADM → COD IO-Link: Parameter → System → User Administration (ADM) → COD
Description	A code can be entered to protect parameter settings against unauthorized and unwanted access.
Input range	0000: Device is permanently unlocked 0001-9999: Device is locked
Factory setting	0000
Note	Locking is enabled after 60 seconds in the measured value display and following a device restart.

Device Access Lock.Local Parametrization Lock ¹⁾

- 1) The "Device Access Lock.Local Parametrization Lock" parameter is an IO-Link standard parameter. The name of the parameter may be available in the language configured in the IO-Link operating tool that is used. The display depends on the particular operating tool.

Navigation IO-Link: Parameter → System → User Administration → Device Access Lock.Local Parametrization Lock ¹⁾

- 1) The "Device Access Lock.Local Parametrization Lock" parameter is an IO-Link standard parameter. The name of the parameter may be available in the language configured in the IO-Link operating tool that is used. The display depends on the particular operating tool.

Description With this lock, local parameterization at the device can be denied via IO-Link. Locking via this parameter can only be unlocked via IO-Link and not locally. This parameter is only available via IO-Link.

Note Entries are denied if the locking code Device Access Lock.Local Parametrization Lock has been activated via IO-Link.
Entry is not OK: the message "S.LCK" appears for one second on the display against a red background.
Editing is possible if locking has been unlocked via IO-Link.

DVA Measured value display

Navigation Display: Display: EF → DIS → DVA
IO-Link: Parameter → System → Display → DVA

Description Configuration of the measured value display and display of the configured switch point.

Options

- PV = display measured value
- PV,/' = display measured value as a percent (only for devices with a current output)
 - 0% is equivalent to LRV
 - 100% is equivalent to URV
- SP1 = display of set switch point

Factory setting PV

DRO Display measured value rotated by 180°

Navigation Display: EF → DIS → DRO
IO-Link: Parameter → System → Display → DRO

Description Use this function to rotate the measured value display by 180°.

Options

- NO
- YES

DOF Switch display on or off

Navigation

Display: EF → DIS → DOF

IO-Link: Parameter → System → Display → DOF

Description

Use this function to switch the display on or off.

When the user exits the menu, there is a delay of 30 seconds until the display is switched off (including background lighting).

Options

- NO
- YES

15.1 Observation

The process data →  31 are transmitted acyclically.

16 Accessories

16.1 Weld-in adapter

Various weld-in adapters are available for installation in vessels or pipes.

Device	Description	Option ¹⁾	Order number
PTP33B	Weld-in adapter M24, d=65, 316L	PM	71041381
PTP33B	Weld-in adapter M24, d=65, 316L 3.1 EN10204-3.1 material, inspection certificate	PN	71041383
PTP31B	Weld-in adapter G½, 316L	QA	52002643
PTP31B	Weld-in adapter G½, 316L 3.1 EN10204-3.1 material, inspection certificate	QB	52010172
PTP31B	Weld-in tool adapter G½, brass	QC	52005082
PTP33B	Weld-in adapter G1, 316L, conical metal joint	QE	52005087
PTP33B	Weld-in adapter G1, 316L, 3.1, conical metal joint, EN10204-3.1 material, inspection certificate	QF	52010171
PTP33B	Weld-in tool adapter G1, brass	QG	52005272
PTP33B	Weld-in adapter G1, 316L, silicone O-ring seal	QJ	52001051
PTP33B	Weld-in adapter G1, 316L, 3.1, silicone O-ring seal, EN10204-3.1 material, inspection certificate	QK	52011896

1) Product Configurator, order code for "Enclosed accessories"

If installed horizontally and weld-in adapters with a leakage hole are used, ensure that the leakage hole is pointing down. This allows leaks to be detected as quickly as possible.

16.2 Process adapter M24

The following process adapters can be ordered for the process connections with order option X2J and X3J:

Device	Description	Order number	Order number with inspection certificate 3.1 EN10204
PTP33B	Varivent F DN32 PN40	52023996	52024003
PTP33B	Varivent N DN50 PN40	52023997	52024004
PTP33B	DIN11851 DN40	52023999	52024006
PTP33B	DIN11851 DN50	52023998	52024005
PTP33B	SMS 1½"	52026997	52026999
PTP33B	Clamp 1½"	52023994	52024001
PTP33B	Clamp 2"	52023995	52024002

16.3 M12 plug connectors

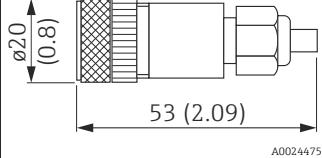
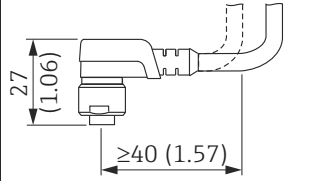
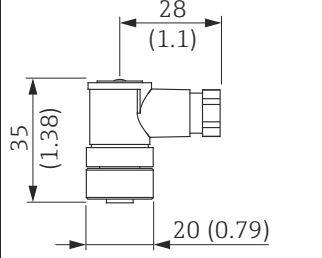
Connector	Degree of protection	Material	Option ¹⁾	Order number
<p>M12 (self-terminated connection at M12 plug)</p>  <p style="text-align: right; font-size: small;">A0024475</p>	IP67	<ul style="list-style-type: none"> ■ Union nut: Cu Sn/Ni ■ Body: PBT ■ Seal: NBR 	R1	52006263
<p>M12 90 degrees with 5m (16 ft) cable</p>  <p style="text-align: right; font-size: small;">A0024476</p>	IP67	<ul style="list-style-type: none"> ■ Union nut: GD Zn/Ni ■ Body: PUR ■ Cable: PVC <p>Cable colors</p> <ul style="list-style-type: none"> ■ 1 = BN = brown ■ 2 = WT = white ■ 3 = BU = blue ■ 4 = BK = black 	RZ	52010285
<p>M12 90 degrees (self-terminated connection at M12 plug)</p>  <p style="text-align: right; font-size: small;">A0024478</p>	IP67	<ul style="list-style-type: none"> ■ Union nut: GD Zn/Ni ■ Body: PBT ■ Seal: NBR 	RM	71114212

1) Product Configurator, order code for "Enclosed accessories"

17 Technical data

17.1 Input

17.1.1 Measured variable

Measured process variable

Gauge pressure or absolute pressure

Calculated process variable

Pressure

17.1.2 Measuring range

Ceramic process isolating diaphragm

Sensor	Device	Maximum Sensor measuring range		Lowest calibratable span ¹⁾	MWP	OPL	Factory settings ²⁾	Option ³⁾
		lower (LRL)	upper (URL)					
		[bar (psi)]	[bar (psi)]					
Devices for gauge pressure measurement								
100 mbar (1.5 psi) ⁴⁾	PTC31B	-0.1 (-1.5)	+0.1 (+1.5)	0.02 (0.3)	2.7 (40.5)	4 (60)	0 to 100 mbar (0 to 1.5 psi)	1C
250 mbar (4 psi) ⁵⁾	PTC31B	-0.25 (-4)	+0.25 (+4)	0.05 (1)	3.3 (49.5)	5 (75)	0 to 250 mbar (0 to 4 psi)	1E
400 mbar (6 psi) ⁶⁾	PTC31B	-0.4 (-6)	+0.4 (+6)	0.08 (1.2)	5.3 (79.5)	8 (120)	0 to 400 mbar (0 to 6 psi)	1F
1 bar (15 psi) ⁶⁾	PTC31B	-1 (-15)	+1 (+15)	0.2 (3)	6.7 (100.5)	10 (150)	0 to 1 bar (0 to 15 psi)	1H
2 bar (30 psi) ⁶⁾	PTC31B	-1 (-15)	+2 (+30)	0.4 (6)	12 (180)	18 (270)	0 to 2 bar (0 to 30 psi)	1K
4 bar (60 psi) ⁶⁾	PTC31B	-1 (-15)	+4 (+60)	0.8 (12)	16.7 (250.5)	25 (375)	0 to 4 bar (0 to 60 psi)	1M
10 bar (150 psi) ⁶⁾	PTC31B	-1 (-15)	+10 (+150)	2 (30)	26.7 (400.5)	40 (600)	0 to 10 bar (0 to 150 psi)	1P
40 bar (600 psi) ⁶⁾	PTC31B	-1 (-15)	+40 (+600)	8 (120)	40 (600)	60 (900)	0 to 40 bar (0 to 600 psi)	1S
Devices for absolute pressure measurement								
100 mbar (1.5 psi) ⁶⁾	PTC31B	0	+0.1 (+1.5)	0.1 (1.5)	2.7 (40.5)	4 (60)	0 to 100 mbar (0 to 1.5 psi)	2C
250 mbar (4 psi) ⁶⁾	PTC31B	0	+0.25 (+4)	0.25 (4)	3.3 (49.5)	5 (75)	0 to 250 mbar (0 to 4 psi)	2E
400 mbar (6 psi) ⁶⁾	PTC31B	0	+0.4 (+6)	0.4 (6)	5.3 (79.5)	8 (120)	0 to 400 mbar (0 to 6 psi)	2F
1 bar (15 psi) ⁶⁾	PTC31B	0	+1 (+15)	0.4 (6)	6.7 (100.5)	10 (150)	0 to 1 bar (0 to 15 psi)	2H
2 bar (30 psi) ⁶⁾	PTC31B	0	+2 (+30)	0.4 (6)	12 (180)	18 (270)	0 to 2 bar (0 to 30 psi)	2K
4 bar (60 psi) ⁶⁾	PTC31B	0	+4 (+60)	0.8 (12)	16.7 (250.5)	25 (375)	0 to 4 bar (0 to 60 psi)	2M
10 bar (150 psi) ⁶⁾	PTC31B	0	+10 (+150)	2 (30)	26.7 (400.5)	40 (600)	0 to 10 bar (0 to 150 psi)	2P
40 bar (600 psi) ⁶⁾	PTC31B	0	+40 (+600)	8 (120)	40 (600)	60 (900)	0 to 40 bar (0 to 600 psi)	2S

1) Highest turn down that can be set at the factory: 5:1. The turn down is preset and cannot be changed.

2) Other measuring ranges (e.g. -1 to +5 bar (-15 to 75 psi)) can be ordered with customer-specific settings (see the Product Configurator, order code for "Calibration; Unit" option "U"). It is possible to invert the output signal (LRV = 20 mA; URV = 4 mA). Prerequisite: URV < LRV

3) Product Configurator, order code for "Sensor range"

4) Vacuum resistance: 0.7 bar (10.5 psi) abs

5) Vacuum resistance: 0.5 bar (7.5 psi) abs

6) Vacuum resistance: 0 bar (0 psi) abs

Maximum turn down which can be ordered for absolute pressure and gauge pressure sensors

Devices for gauge pressure measurement

- 6 bar (90 psi), 16 bar (240 psi), 25 bar (375 psi): TD 1:1 to TD 2.5:1
- All other measuring ranges: TD 1:1 to TD 5:1

Devices for absolute pressure measurement

- 100 mbar (1.5 psi), 250 mbar (4 psi), 400 mbar (6 psi): TD 1:1
- 1 bar (15 psi): TD 1:1 to TD 2.5:1
- All other measuring ranges: TD 1:1 to TD 5:1

Metal process isolating diaphragm

Sensor	Device	Maximum Sensor measuring range		Lowest calibratable span ¹⁾	MWP	OPL	Factory settings ²⁾	Option ³⁾
		lower (LRL)	upper (URL)					
		[bar (psi)]	[bar (psi)]					
Devices for gauge pressure measurement								
400 mbar (6 psi) ⁴⁾	PTP31B PTP33B	-0.4 (-6)	+0.4 (+6)	0.4 (6)	1 (15)	1.6 (24)	0 to 400 mbar (0 to 6 psi)	1F
1 bar (15 psi) ⁴⁾	PTP31B PTP33B	-1 (-15)	+1 (+15)	0.4 (6)	2.7 (40.5)	4 (60)	0 to 1 bar (0 to 15 psi)	1H
2 bar (30 psi) ⁴⁾	PTP31B PTP33B	-1 (-15)	+2 (+30)	0.4 (6)	6.7 (100.5)	10 (150)	0 to 2 bar (0 to 30 psi)	1K
4 bar (60 psi) ⁴⁾	PTP31B PTP33B	-1 (-15)	+4 (+60)	0.8 (12)	10.7 (160.5)	16 (240)	0 to 4 bar (0 to 60 psi)	1M
10 bar (150 psi) ⁴⁾	PTP31B PTP33B	-1 (-15)	+10 (+150)	2 (30)	25 (375)	40 (600)	0 to 10 bar (0 to 150 psi)	1P
40 bar (600 psi) ⁴⁾	PTP31B PTP33B	-1 (-15)	+40 (+600)	8 (120)	100 (1500)	160 (2400)	0 to 40 bar (0 to 600 psi)	1S
100 bar (1 500 psi) ⁴⁾	PTP31B	-1 (-15)	+100 (+1500)	20 (300)	100 (1500)	160 (2400)	0 to 100 bar (0 to 1 500 psi)	1U
400 bar (6 000 psi) ⁴⁾	PTP31B	-1 (-15)	+400 (+6000)	80 (1200)	400 (6000)	600 (9000)	0 to 400 bar (0 to 6 000 psi)	1W
Devices for absolute pressure measurement								
400 mbar (6 psi) ⁴⁾	PTP31B PTP33B	0 (0)	0.4 (+6)	0.4 (6)	1 (15)	1.6 (24)	0 to 400 mbar (0 to 6 psi)	2F
1 bar (15 psi) ⁴⁾	PTP31B PTP33B	0 (0)	1 (+15)	0.4 (6)	2.7 (40.5)	4 (60)	0 to 1 bar (0 to 15 psi)	2H
2 bar (30 psi) ⁴⁾	PTP31B PTP33B	0 (0)	2 (+30)	0.4 (6)	6.7 (100.5)	10 (150)	0 to 2 bar (0 to 30 psi)	2K
4 bar (60 psi) ⁴⁾	PTP31B PTP33B	0 (0)	4 (+60)	0.8 (12)	10.7 (160.5)	16 (240)	0 to 4 bar (0 to 60 psi)	2M
10 bar (150 psi) ⁴⁾	PTP31B PTP33B	0 (0)	10 (+150)	2 (30)	25 (375)	40 (600)	0 to 10 bar (0 to 150 psi)	2P
40 bar (600 psi) ⁴⁾	PTP31B PTP33B	0 (0)	+40 (+600)	8 (120)	100 (1500)	160 (2400)	0 to 40 bar (0 to 600 psi)	2S
100 bar (1 500 psi) ⁴⁾	PTP31B	0 (0)	+100 (+1500)	20 (300)	100 (1500)	160 (2400)	0 to 100 bar (0 to 1 500 psi)	2U
400 bar (6 000 psi) ⁴⁾	PTP31B	0 (0)	+400 (+6000)	80 (1200)	400 (6000)	600 (9000)	0 to 400 bar (0 to 6 000 psi)	2W

- 1) Highest turn down that can be set at the factory: 5:1. The turn down is preset and cannot be changed.
- 2) Other measuring ranges (e.g. -1 to +5 bar (-15 to 75 psi)) can be ordered with customer-specific settings (see the Product Configurator, order code for "Calibration; Unit" option "U"). It is possible to invert the output signal (LRV = 20 mA; URV = 4 mA). Prerequisite: URV < LRV
- 3) Product Configurator, order code for "Sensor range"
- 4) Vacuum resistance: 0.01 bar (0.145 psi) abs

Maximum turn down which can be ordered for absolute pressure and gauge pressure sensors

Ranges 0.5%/0.3%: TD 1:1 to TD 5:1

17.2 Output

17.2.1 Output signal

Designation	Option ¹⁾
PNP switch output + 4 to 20 mA output (4-wire), IO-Link	7
PNP switch output (3-wire)	4
2 x PNP switch output (4-wire), IO-Link	8

1) Product Configurator, order code for "Output"

17.2.2 Range of adjustment

- Switch output
 Switch point (SP): 0.5 to 100 % in increments of 0.1% (min. 1 mbar * (0.015 psi)) of the upper range limit (URL) switchback point (RSP): 0 to 99.5% in increments of 0.1% (min. 1 mbar * (0.015 psi)) of the upper range limit (URL)
 Minimum distance between SP and RSP: 0.5 % URL
- Analog output (if available)
 Lower range value (LRV) and upper range value (URV) can be set anywhere within the sensor range (LRL - URL). Turn down for analog output up to 5:1 of upper sensor limit (URL).
- Factory setting (if no customer-specific setting is ordered):
 Switch point SP1: 90 %; switchback point RP1: 10 %;
 Switch point SP2: 95 %; switchback point RP2: 15 %;
 Analog output: LRV 0 %; URV 100 %

* For measuring ranges with a negative gauge pressure up to 4 bar (60 psi), the increment when setting the switch point is min. 10 mbar (0.15 psi)

17.2.3 Switching capacity

- Switch state ON ³⁾: $I_a \leq 200 \text{ mA}$ ⁴⁾; switch state OFF: $I_a \leq 100 \mu\text{A}$
- Switch cycles: >10,000,000
- Voltage drop PNP: $\leq 2 \text{ V}$
- Overload protection: Automatic load testing of switching current;
 - Max. capacitive load: 1 μF at max. supply voltage (without resistive load)
 - Max. cycle duration: 0.5 s; min. t_{on} : 40 μs
 - Periodic disconnection from protective circuit in the event of overcurrent ($f = 2 \text{ Hz}$) and "F804" displayed

17.2.4 Signal range 4 to 20 mA

3.8 mA to 20.5 mA

17.2.5 Load (for devices with analog output)

In order to guarantee sufficient terminal voltage, a maximum load resistance R_L (including line resistance) must not be exceeded depending on the supply voltage U_B of the supply unit.

The maximum load resistance depends on the terminal voltage and is calculated according to the following formula:

3) 100 mA can be guaranteed over the entire temperature range for the switch outputs "2 x PNP" and "1 x PNP + 4 to 20 mA output". For lower ambient temperatures, higher currents are possible but cannot be guaranteed. Typical value at 20 °C (68 °F) approx. 200 mA. 200 mA can be guaranteed over the entire temperature range for the "1 x PNP" current output.
 4) Larger currents are supported, thus deviating from the IO-Link standard.

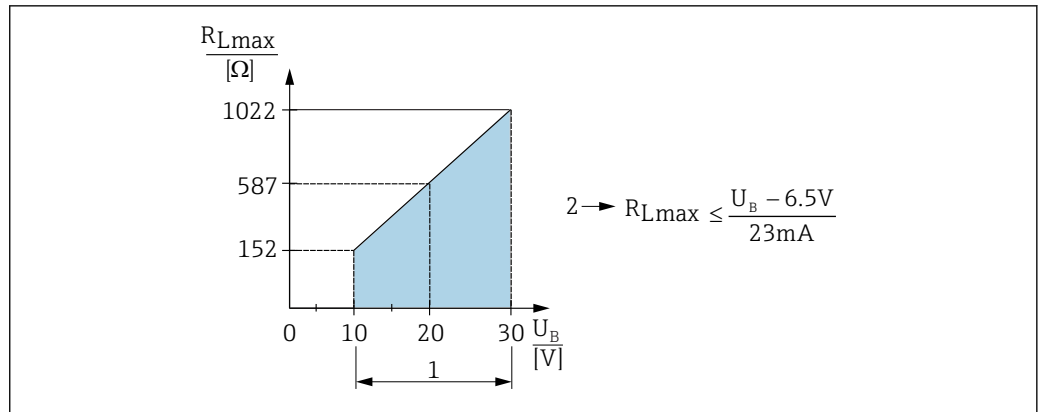

A0031107

- 1 Power supply 10 to 30 V DC
- 2 R_{Lmax} maximum load resistance
- U_B Supply voltage

If load is too great:

- failure current is output and "S803" displayed (output: MIN alarm current)
- Periodic checking to establish if it is possible to quit fault state
- In order to guarantee sufficient terminal voltage, a maximum load resistance R_L (including line resistance) must not be exceeded depending on the supply voltage U_B of the supply unit.

17.2.6 Signal on alarm 4 to 20 mA

The response of the output to error is regulated in accordance with NAMUR NE43.

The behavior of the current output in the event of faults is defined in the following parameters:

- Alarm current FCU "MIN": Lower alarm current (≤ 3.6 mA) (optional, see the following table) → 62
- Alarm current FCU "MAX" (factory setting): Upper alarm current (≥ 21 mA) → 62
- Alarm current FCU "HLD" (HOLD) (optional, see the following table): Last measured current value is held. When the device starts, the current output is set to "Lower alarm current" (≤ 3.6 mA). → 62

- i**
 - The selected alarm current is used for all errors.
 - Errors and warning messages are displayed via IO-Link.
 - Errors and warning messages are displayed only on the primary value page (topmost display level) and are not displayed in the operating menu.
 - In the operating menu the error is only indicated by the color of the display background.
 - The status LED always indicates an error.
 - It is not possible to acknowledge errors and warnings. The relevant message disappears if the event is no longer pending.
 - The failsafe mode can be changed directly when a device is running (see the following table).

Changing the failsafe mode	After confirming with \square
from MAX to MIN	active immediately
from MIN to MAX	active immediately
from HLD (HOLD) to MAX	active immediately
from HLD (HOLD) to MIN	active immediately
from MIN to HLD (HOLD)	active outside the fault state
from MAX to HLD (HOLD)	active outside the fault state

alarm current

Device	Description	Option
PTC31B PTP31B PTP33B	Adjusted min. alarm current	IA ¹⁾
PTC31B PTP31B PTP33B	1 low ≤3.6 mA 2 high ≥21 mA 3 last current value	U ²⁾

1) Product Configurator order code for "Service"

2) Product Configurator order code for "Calibration/unit"

17.2.7 Dead time, time constant

Presentation of the dead time and the time constant:

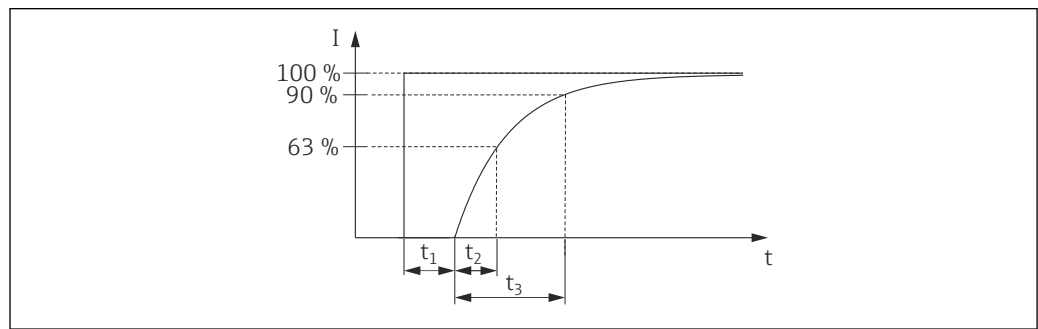

A0019786

17.2.8 Dynamic behavior

Analog electronics

Dead time (t_1) [ms]	Time constant (T63), t_2 [ms]	Time constant (T90), t_3 [ms]
7 ms	11 ms	16 ms

17.2.9 Dynamic behavior of switch output

PNP switch output and 2 x PNP switch output: response time ≤20 ms

17.3 Performance characteristics of ceramic process isolating diaphragm

17.3.1 Reference operating conditions

- As per IEC 60770
- Ambient temperature T_A = constant, in the range of: +21 to +33 °C (+70 to +91 °F)
- Humidity φ = constant, in the range of 5 to 80 % rH
- Ambient pressure p_A = constant, in the range of: 860 to 1060 mbar (12.47 to 15.37 psi)
- Position of measuring cell = constant, in range: horizontal $\pm 1^\circ$ (see also "Influence of the installation position" section →  16)
- Zero based span
- Material of process isolating diaphragm: Al_2O_3 (aluminum-oxide ceramic, Ceraphire®)
- Supply voltage: 24 V DC ± 3 V DC
- Load: 320 Ω (at 4 to 20 mA output)

17.3.2 Measuring uncertainty for small absolute pressure measuring ranges

The smallest extended uncertainty of measurement that can delivered by our standards is:

- in range 1 to 30 mbar (0.0145 to 0.435 psi): 0.4 % of reading
- in range < 1 mbar (0.0145 psi): 1 % of reading.

17.3.3 Influence of the installation position

→  16

17.3.4 Resolution

Current output: min. 1.6 μ A

Display: can be set (factory setting: presentation of the maximum accuracy of the transmitter)

17.3.5 Reference accuracy

The reference accuracy contains the non-linearity [DIN EN 61298-2 3.11] including the pressure hysteresis [DIN EN 61298-23.13] and non-repeatability [DIN EN 61298-2 3.11] in accordance with the limit point method as per [DIN EN 60770].

Device	% of the calibrated span to the maximum turn down		
	Reference accuracy	Non-linearity ¹⁾	Non-repeatability
PTC31B - standard	± 0.5	± 0.1	± 0.1
PTC31B - platinum	± 0.3	± 0.1	± 0.1

1) The non-linearity for the 40 bar (600 psi) sensor can be up to $\pm 0.15\%$ of the calibrated span up to the maximum turn down.

Overview of the turn down ranges →  78

17.3.6 Thermal change of the zero output and the output span

Measuring cell	-20 to +85 °C (-4 to +185 °F)	-40 to -20 °C (-40 to -4 °F) +85 to +100 °C (+185 to +212 °F)
	% of URL for TD 1:1	
<1 bar (15 psi)	<1	<1.2
≥ 1 bar (15 psi)	<0.8	<1

17.3.7 Long-term stability

1 year	5 years	8 years
% of URL		
±0.2	±0.4	In preparation

17.3.8 Switch-on time

≤2 s (For small measuring ranges, pay attention to the thermal compensation effects.)

17.4 Performance characteristics of metal process isolating diaphragm

17.4.1 Reference operating conditions

- As per IEC 60770
- Ambient temperature T_A = constant, in the range: +21 to +33 °C (+70 to +91 °F)
- Humidity φ = constant, in the range: 5 to 80 % rH
- Ambient pressure p_A = constant, in the range: 860 to 1 060 mbar (12.47 to 15.37 psi)
- Position of measuring cell = constant, in the range: horizontal $\pm 1^\circ$ (see also "Influence of the installation position" section →  16)
- Zero based span
- Process isolating diaphragm material: AISI 316L (1.4435)
- Filling oil: synthetic oil polyalphaolefin FDA 21 CFR 178.3620, NSF H1
- Supply voltage: 24 V DC ± 3 V DC
- Load: 320 Ω (at 4 to 20 mA output)

17.4.2 Measuring uncertainty for small absolute pressure measuring ranges

The smallest extended uncertainty of measurement that can delivered by our standards is:

- in the range 1 to 30 mbar (0.0145 to 0.435 psi): 0.4 % of reading
- in the range < 1 mbar (0.0145 psi): 1 % of reading.

17.4.3 Influence of the installation position

→  16

17.4.4 Resolution

Current output: min. 1.6 μ A

Display: can be set (factory setting: presentation of the maximum accuracy of the transmitter)

17.4.5 Reference accuracy

The reference accuracy contains the non-linearity [DIN EN 61298-2 3.11] including the pressure hysteresis [DIN EN 61298-23.13] and non-repeatability [DIN EN 61298-2 3.11] in accordance with the limit point method as per [DIN EN 60770].

Device	% of the calibrated span to the maximum turn down		
	Reference accuracy	Non-linearity	Non-repeatability
PTP31B - standard	± 0.5	± 0.1	± 0.1
PTP31B - platinum	± 0.3	± 0.1	± 0.1
PTP33B - standard	± 0.5	± 0.1	± 0.1
PTP33B - platinum	± 0.3	± 0.1	± 0.1

Overview of the turn down ranges →  79

17.4.6 Thermal change of the zero output and the output span

PTP31B

Measuring cell	-20 to +85 °C (-4 to +185 °F)	-40 to -20 °C (-40 to -4 °F) +85 to +100 °C (+185 to +212 °F)
	% of the calibrated span for TD 1:1	
<1 bar (15 psi)	<1	<1.2
≥ 1 bar (15 psi)	<0.8	<1

PTP33B

Measuring cell	-20 to +85 °C (-4 to +185 °F)	-40 to -20 °C (-40 to -4 °F) +85 to +100 °C (+185 to +212 °F)
	% of the calibrated span for TD 1:1	
<1 bar (15 psi)	<1	<1.2
≥ 1 bar (15 psi)	<0.8	<1

17.4.7 Long-term stability

Device	1 year	5 years	8 years
	% of URL		

17.4.8 Switch-on time

≤2 s

For small measuring ranges, pay attention to the thermal compensation effects.

17.5 Environment

17.5.1 Ambient temperature range

Device	Ambient temperature range ¹⁾
PTC31B	-20 to +70 °C (-4 to +158 °F)
PTP31B	IO-Link: -40 to +70 °C (-40 to +158 °F)
PTP33B	(in the range of the temperature limits with restrictions in optical properties, such as display speed and contrast)

1) Exception: the following cable is designed for an ambient temperature range of -25 to +70 °C (-13 to +158 °F): Product Configurator order code for "Enclosed accessories" option "RZ".

17.5.2 Storage temperature range

-40 to +85 °C (-40 to +185 °F)

17.5.3 Climate class

Device	Climate class	Note
PTC31B PTP31B PTP33B	Class 3K5	Air temperature: -5 to +45 °C (+23 to +113 °F), relative humidity: 4 to 95 % satisfied according to IEC 721-3-3 (condensation not possible)

17.5.4 Degree of protection

Device	Connection	Degree of protection	Option ¹⁾
PTC31B PTP31B PTP33B	M12 plug	IP65/67 NEMA type 4X enclosure	M

1) Product Configurator order code for "Electrical connection"

17.5.5 Vibration resistance

Test standard	Vibration resistance
IEC 60068-2-64:2008	Guaranteed for 5 to 2000Hz: 0.05g ² /Hz

17.5.6 Electromagnetic compatibility

- Interference emission as per EN 61326-1 equipment B
- Interference immunity as per EN 61326-1 (industrial environment)
- For intended use, the switch output can switch to the communication mode for 0.2 s in the event of transient faults.
- Maximum deviation: 1.5% with TD 1:1

For more details, please refer to the Declaration of Conformity.

17.6 Process

17.6.1 Process temperature range for devices with ceramic process isolating diaphragm

Device	Process temperature range
PTC31B	-25 to +100 °C (-13 to +212 °F)

- For saturated steam applications, use a device with a metal process isolating diaphragm, or provide a siphon for temperature isolation when installing.
- Pay attention to the process temperature range of the seal. See also the following table.

Seal	Notes	Process temperature range	Option
FKM	-	-20 to +100 °C (-4 to +212 °F)	A ¹⁾
FKM	Cleaned for oxygen service	-10 to +60 °C (+14 to +140 °F)	A ¹⁾ and HB ²⁾
EPDM 70	-	-25 to +100 °C (-13 to +212 °F)	J ¹⁾

- 1) Product Configurator, order code for "Seal"
 2) Product Configurator, order code for "Service"

Applications with changes in temperature

Frequent extreme changes in temperatures can temporarily cause measuring errors. Temperature compensation takes place after a few minutes. Internal temperature compensation is faster the smaller the change in temperature and the longer the time interval.

For further information please contact your local Endress+Hauser Sales Center.

17.6.2 Process temperature range for devices with metallic process isolating diaphragm

Device	Process temperature range
PTP31B	-40 to +100 °C (-40 to +212 °F)
PTP33B	-10 to +100 °C (+14 to +212 °F)
PTP33B Sterilization in place (SIP)	At +135°C (+275 °F) for a maximum of one hour (device in operation but not within measuring specification)

Applications with changes in temperature

Frequent extreme changes in temperatures can temporarily cause measuring errors. Internal temperature compensation is faster the smaller the change in temperature and the longer the time interval.

For further information please contact your local Endress+Hauser Sales Center.

17.6.3 Pressure specifications

⚠ WARNING

The maximum pressure for the measuring device depends on the lowest-rated element with regard to pressure.

- ▶ For pressure specifications, see the "Measuring range" section and "Mechanical construction" section in the Technical Information.
- ▶ The Pressure Equipment Directive (2014/68/EU) uses the abbreviation "PS". The abbreviation "PS" corresponds to the MWP (maximum working pressure) of the measuring device.
- ▶ MWP (maximum working pressure): The MWP (maximum working pressure) is specified on the nameplate. This value is based on a reference temperature of +20 °C (+68 °F) and may be applied to the device for an unlimited period of time. Observe the temperature dependency of the MWP.
- ▶ OPL (over pressure limit): The test pressure corresponds to the over pressure limit of the sensor and may only be applied temporarily to ensure that the measurement is within the specifications and no permanent damage develops. In the case of sensor range and process connections where the over pressure limit (OPL) of the process connection is smaller than the nominal value of the sensor, the device is set at the factory, at the very maximum, to the OPL value of the process connection. If you want to use the entire sensor range, select a process connection with a higher OPL value.
- ▶ Devices with ceramic process isolating diaphragm: avoid steam hammering! Steam hammering can cause zero point drifts. Recommendation: Residue (water droplets or condensation) may remain on the process isolating diaphragm following CIP cleaning and can result in local steam hammering the next time steam cleaning takes place. In practice, drying the process isolating diaphragm (e.g. by blowing) has proved to prevent steam hammering.

Index

A

Actual Diagnostics (STA)	56
Alarm current (FCU)	62
Application	9
Application Specific Tag	56

C

CE mark (declaration of conformity)	10
Cleaning	49
COD (locking code)	72
Configuration of a pressure measurement	36
Configuring pressure measurement	36

D

Damping (TAU)	60
Declaration of Conformity	10
Designated use	9
Device Access Lock.Local Parametrization Lock	73
Device Access Locks.Data Storage Lock (activation/ deactivation of Data Storage)	72
Device Search	57
Diagnosis	
Symbols	45
Diagnostic event	45
Diagnostic events	45
Diagnostic message	45
Display: HI	70
Display: LO	71
Disposal	50
DOF	73
DRO	73
DVA	73

E

ENP_VERSION	56
Event text	45
Extended Ordercode	56
Exterior cleaning	49

F

Field of application	
Residual risks	9

H

Hysteresis	63, 65
----------------------	--------

I

In alarm condition	45
IO-Link menu	
Overview	54
IO-Link operating menu	
Overview	54
IO-Link: HI Max value (maximum indicator)	70
IO-Link: LO Min value (minimum indicator)	71

L

Last Diagnostic (LST)	56
---------------------------------	----

LCK (unlocking code)	72
--------------------------------	----

Local display	
see Diagnostic message	
see In alarm condition	

M

Maintenance	48
Media	9
Menu	
Parameter description	56

N

Nameplate	14
---------------------	----

O

Onsite display menu	
Overview	51
Onsite display operating menu	
Overview	51
Operating menu	
Parameter description	56
Operating Mode (FUNC)	40, 58
Operational safety	10
Output 1 (OU1)	70
Output 2 (OU2)	70

P

Pressure applied for 4mA (GTL)	41, 61
Pressure applied for 20mA (GTU)	42, 62
Product safety	10

R

Repair concept	50
Reset to factory settings (RES)	71
Revisioncounter (RVC)	71

S

Safety instructions	
Basic	9
Simulation Current Output (OU2)	57
Simulation Switch Output (OU1)	56
SM2 for devices with 2 switch outputs	58
Staff	
Requirements	9
Status signals	45
Switch point value / Upper value for pressure window, output 1 (SP1 / FH1)	63
Switch point value / Upper value for pressure window, output 2 (SP2 / FH2)	65
Switchback delay time, output 1 (dR1)	67
Switchback delay time, output 2 (dR2)	68
Switchback point value / Lower value for pressure window, output 1 (RP1 / FL1)	63
Switchback point value / Lower value for pressure window, output 2 (RP2 / FL2)	65
Switching delay time, output 1 (dS1)	67
Switching delay time, output 2 (dS2)	68

T

Troubleshooting 44

UUnit changeover (UNI) - μ C-Temperature 58

Using measuring device

Borderline cases 9

Incorrect use 9

see Designated use

V

Value for 4 mA (STL) 40, 60

Value for 20 mA (STU) 41, 61

W

Window function 63, 65

Workplace safety 10

Z

Zero point adoption (GTZ) 38, 59

Zero point configuration (ZRO) 38, 58



71422361

www.addresses.endress.com
